



egg^z®













INSTRUCTION MANUAL

IMPORTANT: READ CAREFULLY AND KEEP FOR FUTURE REFERENCE

IMPORTANT SAFETY INFORMATION

This vehicle is intended for children from birth to a maximum of 22kg. Always follow the manufacturers instructions and never exceed the maximum weight limits. The seat unit is designed for one child to a maximum of 22kg.

When using this stroller for new born babies; always use the most reclined position.

-  **WARNING:** Never leave your child unattended.
-  **WARNING:** This product is not suitable for running or skating.
-  **WARNING:** Ensure that all the locking devices are engaged before use.
-  **WARNING:** To avoid injury ensure that your child is kept away when unfolding and folding this product.
-  **WARNING:** Do not let your child play with this product
-  **WARNING:** This seat unit is suitable for children up to 22kg.
-  **WARNING:** Always use the restraint system in combination with the crotch strap.
-  **WARNING:** Any load attached to the handle and/or the back of the backrest and/or on the sides of the vehicle will affect the stability of the vehicle.
-  **WARNING:** The maximum weight for the shopping basket is 3kg.
-  **WARNING:** Only use the egg accessories approved and recommended by egg.
-  **WARNING:** Never lift/carry the chassis while occupied.
-  **WARNING:** Do not use the vehicle on steps, stairs or escalators; as it may be endanger your child.
-  **WARNING:** Always descend/mount kerbs on the back wheels, do not tip the stroller forward.

PRODUCT INFORMATION

The egg® stroller has been designed with safety and style in mind. Soft touch fabrics create smooth curves and continuous lines to give the egg® a luxury, stylish look. Outstanding engineering creates the perfect ride for baby and ultimate ease of use for parents.

The egg® has been fitted with PU long lasting tyres which have been engineered for comfort, superior handling and added durability. The one-hand fold chassis is easy to use, compact and freestanding when folded . There is a three position recline, lie-flat forward facing seat unit that is spacious and comfortable with a quiet action that won't wake sleeping children when reclined.

- Compact one hand 'Z' fold and free standing.
- Three position recline, forward facing seat unit. 0 to 22kg.
- Complete rain cover.
- Hand stitched PU leather handle grip and bumper bar.
- Large extendable UPF50+ canopy with ventilation/peek-a-boo window.
- Swivel front wheels.
- PU puncture free polymer tyres, long lasting provide smoother ride.
- Removable wheels for compact storage.
- All round suspension.
- Large shopping basket with access to front and rear.
- Co-ordinating accessories include; backpack and seat liner - check with your local retailer or visit eggstroller.com.

Weights and dimensions:

Chassis weight with wheels and seat unit - 9.5kg.

Stroller with wheels folded- 30 x 48 x 67cm (bumper bar removed)

Important Note.

The illustrations used in this manual are intended to show the operation method and product structure. There may be small differences between the drawing and the physical product, please take the physical product as the standard.

**Contents:**

1. Carton
2. Chassis with canopy and covers
3. Front wheels
4. Rain cover
5. Rear wheels
6. Front (bumper bar) bar
7. Instruction manual

7

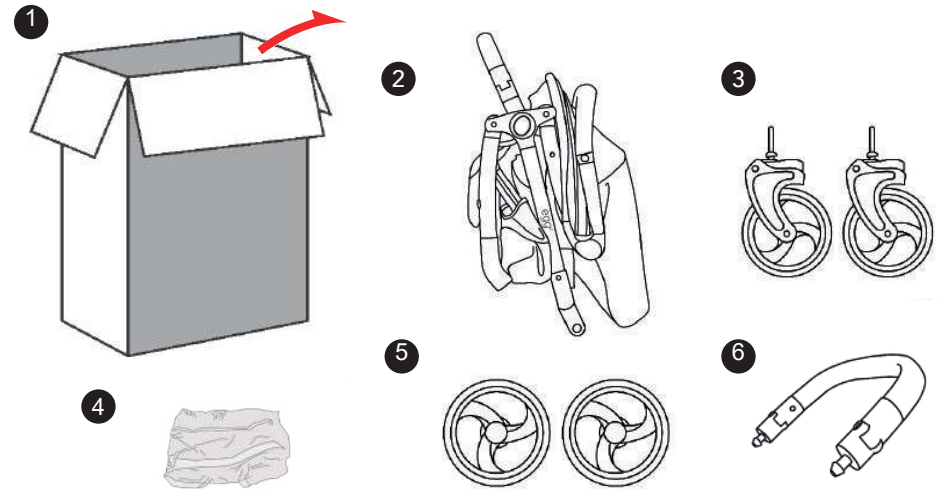
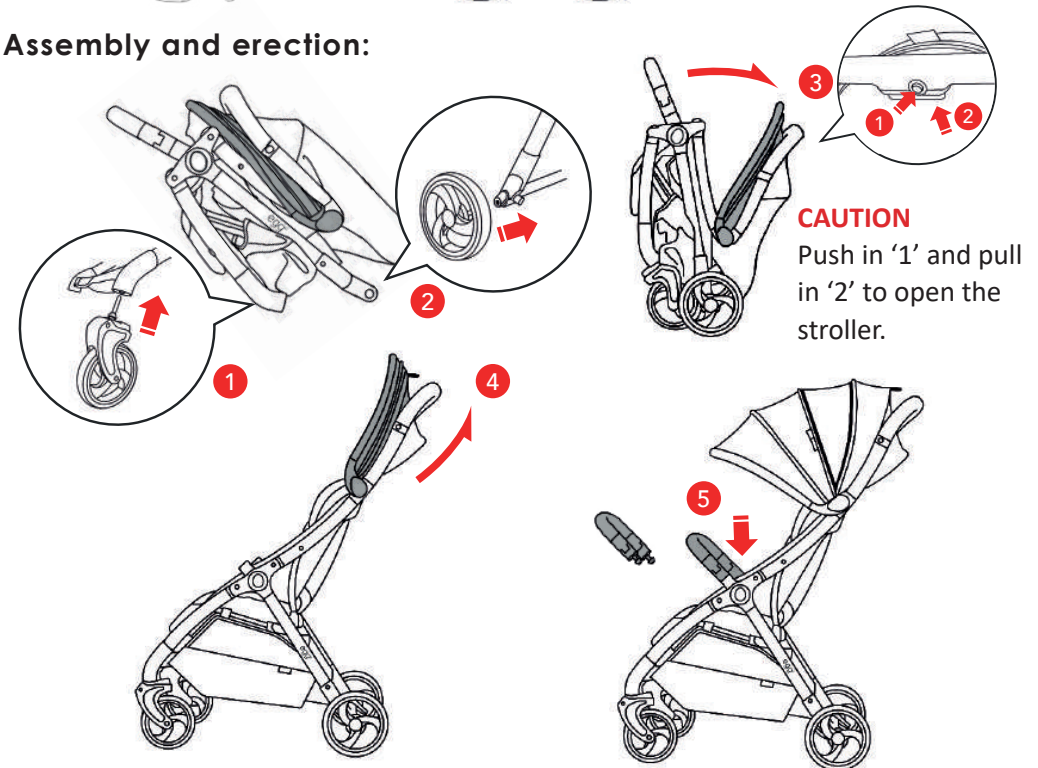

WARNING: Any plastic packaging should be immediately removed and kept out of the reach of children to avoid an suffocation hazard.

**Unpacking****Assembly and erection:**

Fitting the front bar

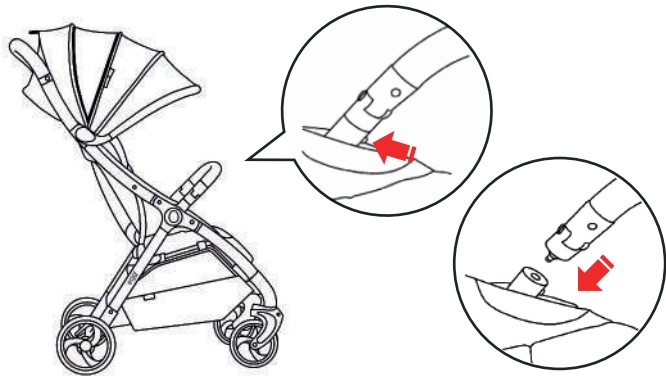

Adjusting the legrest/backrest
squeeze leg support to adjust

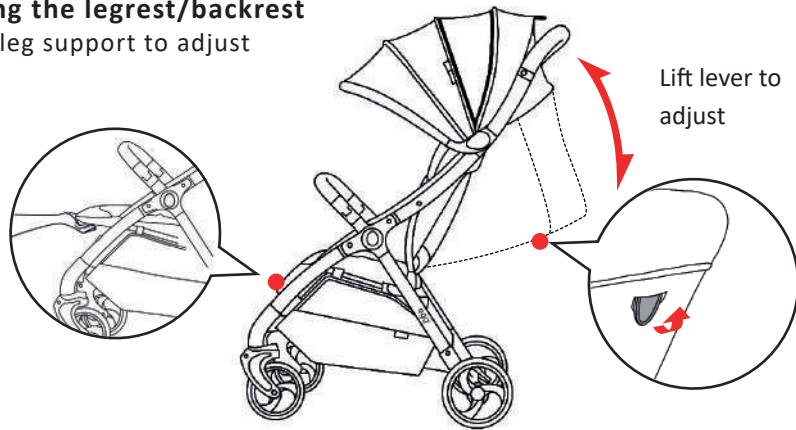

Safety harness with magnetic assist

Press and lift to open.

Lift apart to separate.

Adjust strap length.

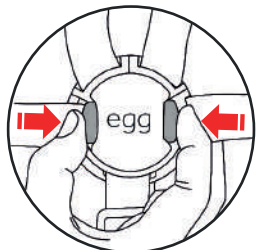

Place on top connect.

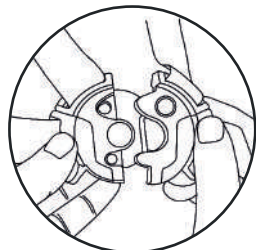

Place together to join.

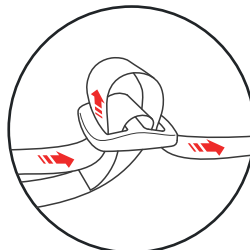

Slide buckles to adjust length of straps.

Operating the parking device

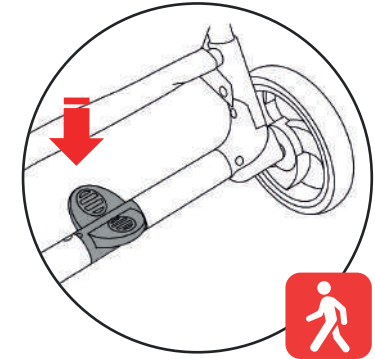
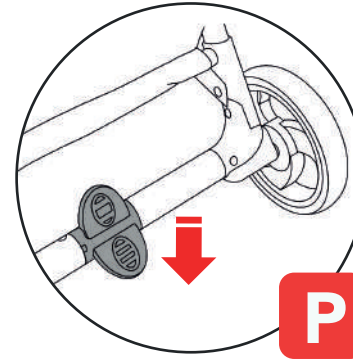

Always engage the parking device, when placing and removing children.

Folding the stroller

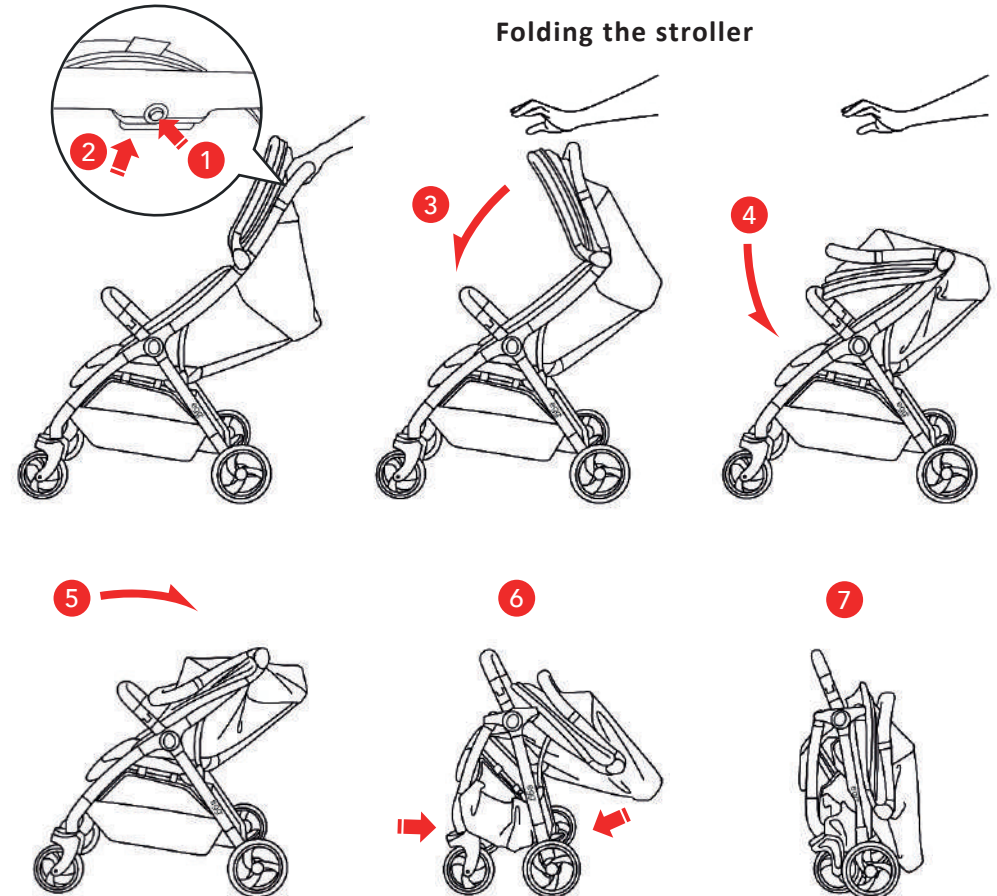

When folded the frame will auto lock, when reopening ensure you press '1' and pull '2'.

Canopy extension: The canopy provides shelter and shade (UPF50+) depending on the conditions. To extend the canopy pull/push the front frame back and forth. The canopy can be opened further when open by undoing the zip on the canopy. The rear top section of the canopy can be folded forwards to provide ventilation and a peek-a-boo window, fold back to close.

Orientate the stroller to provide shade, do not leave the child in direct sun.

Rain Cover: The stroller is provided with a clear coverall rain cover. Always use the rain cover in inclement conditions. To fit the rain cover, unfold the cover and unfasten the large Velcro opening. Place the cover over the stroller so the handle passes through the opening, fasten the Velcro. Connect the two lower front elasticated hooks to one another underneath the front of the stroller. To remove the cover, unfasten the elasticated hooks at the front and release the Velcro under the handle then lift the cover away.

Harness Shoulder height adjustment: Unfasten the harness shoulder straps so that the two short straps dangle from the seat backrest. Insert your hand under the seat back cover and access the buckle on the back of the seat back. Thread the buckle from the seat back through to the front. Reposition the strap to the desired position and replace by reversing the removal procedure. Re attach the harness for use and adjust the strap length to suit the child.

Stroller frame Auto Lock: When folded the frame will auto lock, ensure the shopping basket is empty, anything left in the shopping basket will hinder the fold and may prevent the chassis from auto locking. When reopening/unfolding/erecting the stroller ensure that the auto lock is released by pressing in and pulling the buttons on the handle, failure to do so may damage the auto lock.

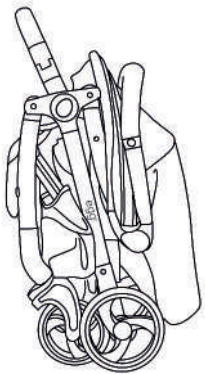

When not in use fold the stroller, the function of auto folding will benefit from folded storage.

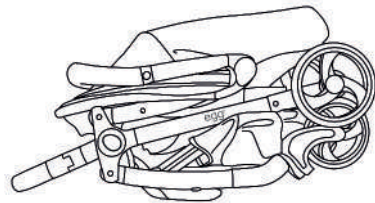

YOUR EGG WARRANTY

At egg we pride ourselves in manufacturing high quality products with our customers' safety and wellbeing at the forefront of our minds.

Registering your egg product.

Thank you for purchasing an egg product. To activate your warranty and register your product visit eggstroller.com and click on 'Register your product' to complete the registration online.

Your warranty policy.

At egg, we guarantee your product has been manufactured in accordance with all current European safety standards which are applicable to this product, and that this product is free from defects in workmanship and material at the time of purchase.

During the production process this product has gone through rigorous quality checks. Despite our efforts, if this product does show a manufacturing or material defect within the 24 months warranty period for the chassis and seat frames and 6 months for seat fabrics and EVA rain cover we will comply with the warranty terms and conditions providing the product has been used for normal use as described within the instructional manual, and it has been serviced and maintained correctly also described within the instruction manual.

For further information please contact the place of purchase. Please retain your original receipt of purchase safely in the back of this booklet.

Warranty terms.

- Chassis and seat frames: 24 consecutive months.
- Seat fabrics accessories and EVA rain cover: 6 consecutive months.
- The warranty only applies to the original purchaser and is non-transferable.

The warranty will be invalidated in the following circumstances:

- This product has not been used for its purpose other than described within the instruction manual.
- If the product is returned for repair through a dealer which is not authorized by us.
- If the original receipt of purchase cannot be provided.
- If the defect is as a result of improper use or incorrect maintenance, negligence or impact damage.
- If the parts show normal wear that may be expected from daily use of the product, (wheels, rotating or moving parts etc).

The warranty of this product becomes valid from the date of purchase as stated on the original receipt of purchase. This does not affect your statutory rights.

Register your product today at eggstroller.com

CARE AND MAINTENANCE

- Regularly check screws, rivets, bolts and fastenings to ensure they are locked tight and secure. Replace any parts in an inferior condition. When using this product during the winter, by the sea or off-road it is important to clean using clean fresh water and dry thoroughly. Salt water and salt and grit from the roads will corrode metal parts unless removed.
- Check on a regular basis that all chassis locking devices are working correctly.
- If any part of the product is damaged, contact your local egg retailer immediately.
- Do not expose the product to excessive sunlight for extended periods of time. Even normal exposure to sunlight may cause change to the colour of the fabrics.
- Take care not to tear fabrics when transporting the product.
- Light oil or silicone spray can be used to lubricate moving parts. Use petroleum jelly to lubricate the front axle stubs. Periodically remove the front swivel wheel units to clean and lubricate using petroleum jelly.
- Ensure zips are either fully open or closed to prevent damage.
- Always use the rain cover in inclement weather.
- Do not place items on top of the hood/canopy it could damage the fabrics or render the product unsafe.
- Any load attached to the handle and/or on the back of the backrest and/or on the sides of the vehicle will affect the stability of the vehicle. Do not hang any load from the handle or chassis when using as a tandem vehicle.
- Tyres can leave marks on some surfaces such as vinyl flooring and carpet.
- Fabrics should be cleaned in accordance to the care labels.
- Do not place fabrics in a washing machine; hand wash or sponge clean only using a mild detergent and warm water (30°C).
- Do not use a buggy board other than the egg ride on board as it may be unsafe and it will invalidate your warranty.

Should you find a defect with this product:

Keep your original receipt of purchase safe with your warranty information as it will be required should you unfortunately find a defect. The receipt must show the date of purchase clearly. In the first instance you must contact the original place of purchase. Exchanging or returning the product cannot be requested. Repairs to any part of this product do not extend the warranty period. Do not return your product direct to the manufacturer.

Servicing of your egg product.

We recommend that this product is regularly maintained and is serviced by an egg authorized dealer at least every 12 months and before upgrading to a tandem mode. Only replacement parts supplied or recommended by the manufacturer/distributor shall be used.

Disclaimer.

Whilst we believe the information set out in this instruction manual to be correct and reliable at the time of print, we do not accept responsibility for its accuracy and we shall not be liable for its interpretation and its use. We reserve the right to change, modify add or delete product specifications at any time without prior notice.

TROUBLE SHOOTING

Chassis will not fold.

Ensure both the small round button and the long grip button are fully pressed in. Do not apply downward or upward force on the handle while activation of the buttons.

Ensure the shopping basket is empty.

Bumper bar will not insert.

Ensure the button below the bumper bar housing is pressed in while inserting the bumper bar, and that there are no obstructions blocking the insertion hole aperture.

Front wheels will not swivel freely.

Remove front wheels, clean axel stubs, lubricate and replace.

egg
36 Charles Street, Sileby,
Leicestershire LE12 7RJ

United Kingdom

T: 01509 816444
E: info@eggstroller.com
eggstroller.com