

IMPORTANT TIPS:

- Only use Baby Brezza Detergent Tablets. DO NOT USE any household dishwasher detergent.
- If your home has hard water/well water, mineral residue may be left on products after drying. To prevent this, we recommend using a water softener or distilled water.
- A small amount of residual water may occasionally remain in concave areas of products after drying, just like your dishwasher. Just tilt the products so the water runs off in the machine.

babybrezza®

bottle washer pro®

Instructions

for set-up, use and cleaning

babybrezza® Customer Service

If you need help with your Baby Brezza Bottle Washer Pro® in the UK or Ireland, visit www.babybrezza.co.uk or email help@cheekyrascals.co.uk. Returns should be made to the store you purchased it from, but before you do, please first contact either Cheeky Rascals or Baby Brezza so that we can give you expert advice customised to your particular situation.

Limited 1-Year Warranty

The limited warranty is valid only on products bought through authorised resellers and used in the UK and Ireland. Buying through an unauthorised reseller or using this product outside of the UK and Ireland automatically voids this warranty.

This warranty is available to consumers only. You are a consumer if you own a Baby Brezza Bottle Washer Pro® that was purchased at retail for personal, family or household use. Except as otherwise required under applicable law, this warranty is not available to retailers or other commercial purchasers or owners. We warrant that your Baby Brezza Bottle Washer Pro® will be free of defects in material or workmanship under normal home use for one year from the date of original purchase when used in accordance with the instructions and maintained correctly. Customers will be required to present original proof of purchase in order to obtain the warranty benefits. In the event that you do not have proof of purchase date, the purchase date for purposes of this warranty will be the date of manufacture. If your Baby Brezza Bottle Washer Pro® should prove to be defective within the warranty period, we will repair it or, if we consider it necessary, replace it.

To obtain warranty services, in the UK or Ireland, please visit www.babybrezza.co.uk. Alternatively, contact help@cheekyrascals.co.uk

ACTIVATE YOUR WARRANTY

Scan here



Benefits:
Faster customer support,
extended customer service
hours & more



KEEP OUT OF REACH OF CHILDREN



FREE
Baby Brezza
Detergent Tablets
included
(1 tablet per use)

babybrezza.co.uk

© 2023 Baby Brezza Enterprises LLC

Distributed in the UK and Ireland by Cheeky Rascals Ltd, Liss Mill, Mill Road, GU33 7BD, UK

For other EU countries, please contact Gamin Tout Terrain, 52 Rue Edouard Pailleron, 75019 Paris France



U.S. Patent Nos. 9782803 & 20140150830

Please read all instructions carefully before first using your bottle washer

IMPORTANT SAFEGUARDS

Please read all instructions carefully before first using your bottle washer.

Essential Safeguards for the wellbeing of you and your baby

1. Keep the appliance, and its detergent tablets, plug and cord out of reach of children.
2. Children should be supervised to ensure that they do not play with the appliance or the detergent tablets
3. Do not allow children to touch or use the appliance or detergent tablets. The appliance becomes very hot and the steam can cause severe scalding.
4. This appliance can be used by children aged from 8 years and above if they have been given supervision or instruction concerning use of the appliance and the detergent tablets in a safe way and understand the hazards involved. Cleaning and user maintenance shall not be made by children unless they are aged from 8 years and above and supervised. Keep the appliance and its cord out of reach of children aged less than 8 years.
5. This appliance is not intended for use by persons (including children) with reduced physical, sensory or mental capabilities, or lack of experience and knowledge, unless they have been given supervision or instruction concerning use of the appliance by a person responsible for their safety.
6. Always use on a level heat-resistant surface.
7. Do not open while in use as this product contains boiling water. Beware of escaping steam from the vent holes in the lid.
8. Steam escaping from the unit can cause burns. Always allow 5 minutes to cool down after the cycle finishes before lifting the lid.
9. Allow at least 30 minutes between uses and make sure the unit has been cooled down before using again.
10. Do not touch the hot surfaces on the appliance.
11. Do not move the appliance when it is in use because it contains hot liquids.
12. Do not use for space heating purposes.
13. This bottle washer is intended for use in residential homes, hotels and other similar lodging and offices/office break rooms.
14. This appliance is for indoor household use only. Do not use outdoors.

Additional precautions relating to the detergent tablets

1. Detergent tablets may pose a choking hazard to children under 3 years of age.
2. **CAUTION:** Detergent tablets are harmful if swallowed or put in mouth. Eye and skin irritant.
3. **DO NOT** ingest. **DO NOT** get in eyes, on skin or clothing.
4. **DO NOT** let children handle tablets.
5. Never leave tablets out of container.

FIRST AID TREATMENT:

If swallowed, call a doctor immediately. Have person drink a glass of water if able to swallow. **DO NOT** induce vomiting.

If in eyes, IMMEDIATELY rinse eyes with water. Remove any contact lenses if present and continue rinsing for 15 minutes. If irritation persists, get medical attention.

If on skin, rinse well with water.

Electrical and other safeguards

When using electrical appliances, basic safety precautions should be followed, including the following:

1. Ensure that the supply voltage marked on the appliance corresponds with your mains supply.
2. To provide continued protection against risk of electric shock, connect to properly grounded power outlets only.
3. Unplug the appliance from the power supply before cleaning or storage.
4. To disconnect power cord, turn appliance over first, then remove plug from power outlet.
5. Always unplug from the electric outlet when not in use. Allow to cool before putting on or taking out any parts.
6. Do not immerse the supply cord, plug or base unit in water or any other liquid.
7. Do not place the appliance on or near hot surfaces, in a heated oven or near a gas or electric heater.

PLEASE SAVE THESE INSTRUCTIONS FOR FUTURE REFERENCE

Baby Brezza Bottle Washer Pro® Parts

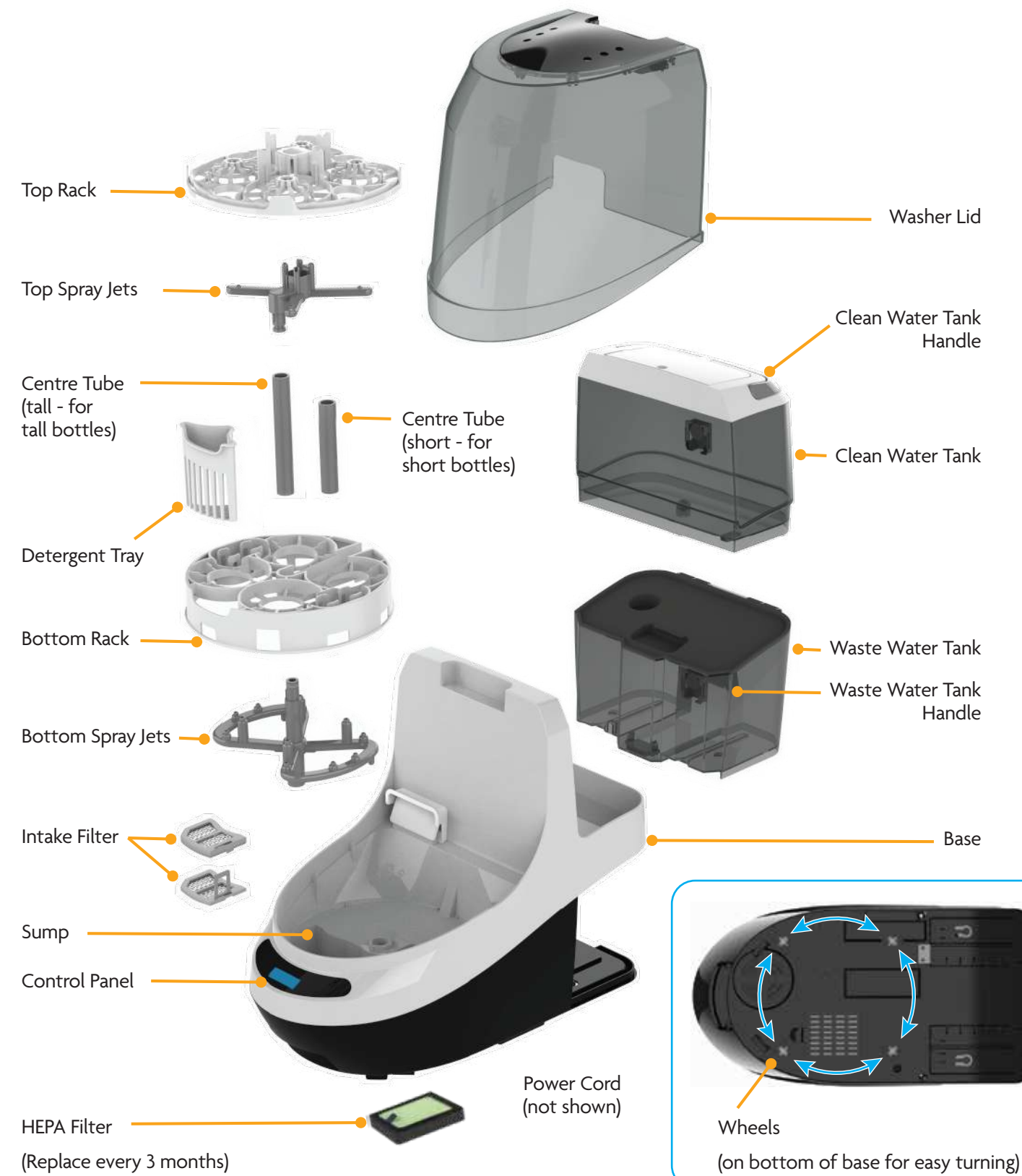

TECHNICAL DATA

Heating Power: 800W, Drying 180W

Model: BRZ0103

Supply Voltage: 220-240V ~ 50/60Hz

Control Panel

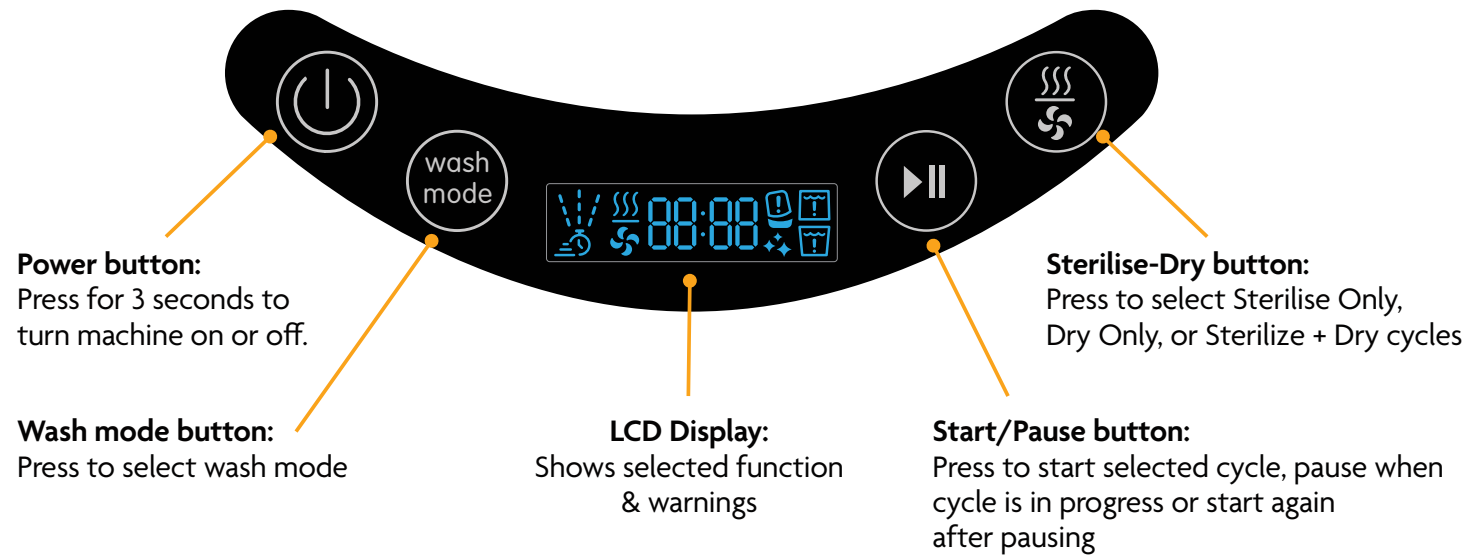

LCD Icons

Wash Modes



Wash & Dry

One 10 minute wash cycle, three 3 minute rinse cycles, & one 60 minute dry cycle.



Wash, Sterilise, Dry

One 10 minute wash cycle, three 3 minute rinse cycles, one 9 minute sterilise cycle, and one 60 minute dry cycle.



Wash Only

One 10 minute wash cycle and three 3 minute rinse cycles.

Warnings and reminders



Lid Warning

Turns on if the start button is pressed without the lid in place, if the lid is opened during operation, or if the lid is not closed completely.



Low Water in Clean Water Tank

Turns on if the water is not filled to the "FILL" line when the start button is pressed.



Water in Waste Water Tank

Turns on if there is waste water in the tank when the start button is pressed or turns on when the waste water tank is full.



Waste Water Tank Not in Place

Turns on if the waste water tank is not on the base or not inserted properly when the start button is pressed.



Clean Water Tank Not in Place

Turns on if the clean water tank is not on the base or not inserted properly when the start button is pressed.



Descaling Reminder

Turns on after 20 uses to remind you to descale the heater plate. Follow descaling instructions on page 8 to descale. Press and hold "wash mode" button for 5 seconds to clear descaling reminder.

Setting up the Bottle Washer Pro®

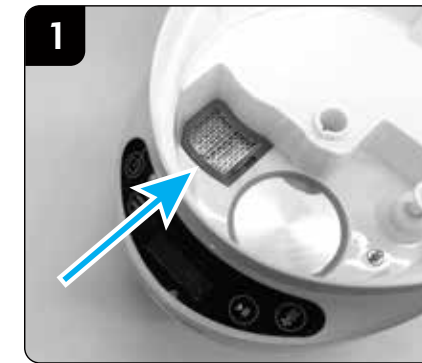

1 Make sure the Intake Filter is placed in the bottom of the sump.

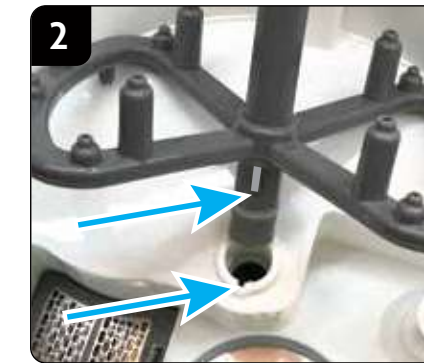

2 Line up the rib on the tube of the Bottom Spray Jets with the slot on the hole in base.



3 Push the Bottom Spray Jets all the way down on the base.



4 Place the Bottom Rack on the Base, over the Bottom Spray Jets.



5 Fit Centre Tube on the Bottom Spray Jets. Use the **short** tube for **short** bottles or the **tall** tube for **tall** bottles



6 Line up the rib in the Top Spray Jet with the Centre Tube and push the Top Spray Jets all the way down.



7 Place the Top Rack on the Top Spray Jets, with the straight edge of the Top Rack facing the back of the machine.



8 The Clean Water Tank can be lifted by the handle. The Waste Water Tank can be pulled out with the handle. Easily turn machine with built-in wheels on bottom.

Now you're ready to put bottles & parts in the Bottle Washer Pro®!
See the following pages for set-up & use

Visit babybrezza.co.uk for set-up videos and more tips

Setting up the Bottle Washer Pro® for Washing, Sterilizing & Drying



1 Fill the Clean Water Tank to the **FILL line** with clean water. You can leave the Water Tank on base and fill with a pitcher.

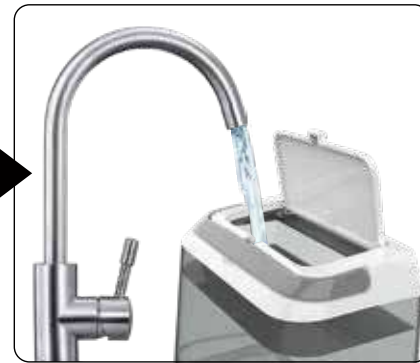

Or you can remove the Clean Water tank from the Base and fill it at the sink.



IMPORTANT Make sure the water is filled to the **FILL line** at the top edge of the clear part of the Clean Water Tank



2 Make sure the Waste Water Tank is empty and pushed all the way into the base.



3 Remove the Lid by grasping the handle and lifting straight up.



4 Place up to 4 bottles **upside down** on the Bottom Rack. Vent tubes or other accessories can be placed over the side jets as shown above.

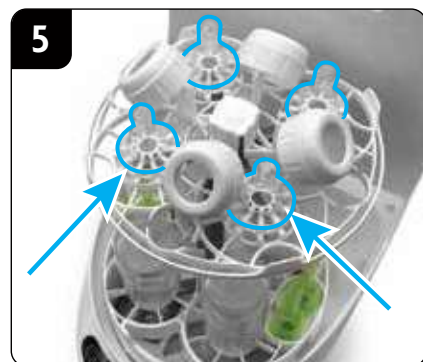

5 Place nipples and accessories **right side up** on the Top Rack, **centered over jets**.



Note: Bottle parts with small pathways should be cleaned thoroughly by hand with brushes supplied by bottle manufacturer before use in the Bottle Washer Pro®.



Note: Large/wide collars and caps may not fit with the bottles & nipples & may need to be washed in a separate cycle.

IMPORTANT: For best results, please rinse milk, other liquid or solids from bottles and accessories before placing in the Bottle Washer Pro®.

Adding Detergent and Starting a Wash Cycle



1 Place **1 Baby Brezza Detergent Tablet** in the detergent tray. It is OK if it falls out of the tray and into the sump.



Do Not Use liquid detergent, household dishwasher detergent or pods. Only use Baby Brezza Detergent Tablets



2 Carefully place the Lid on the Base and make sure it is closed completely.

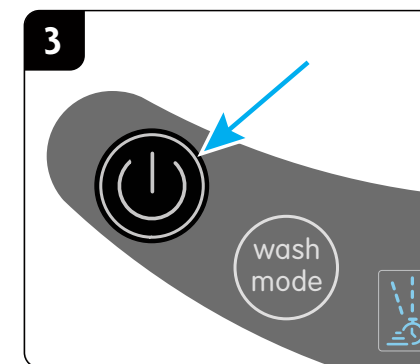

3 Press and hold the “Power” button for 3 seconds to turn on the Bottle Washer Pro®.

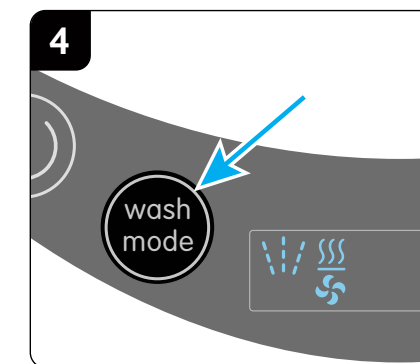

4 Touch the “wash mode” button to choose a wash cycle. **See page 3 for details.**

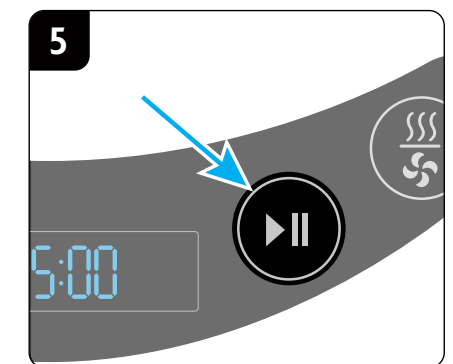

5 Press the “Start/Pause” button to start the Bottle Washer Pro®.

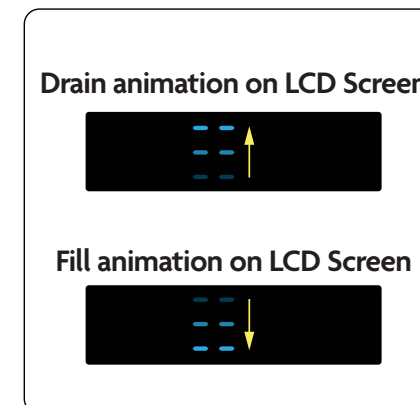

The machine will start by draining the sump to make sure it starts with clean water, then it will begin filling the sump and heating the water.

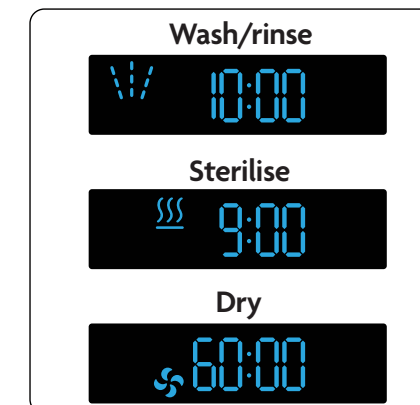

The LCD will show the icon for each cycle and display a timer countdown. When the last cycle is completed, the Bottle Washer Pro® will automatically shut-off.

Pausing the Machine: You can pause the machine at any time by pressing the “Start/Pause” button. **Be careful, the Lid may be hot to touch & steam may escape when you remove the lid.** The machine will turn off after 20 min if not restarted. You can restart the machine by pressing “Start/Pause” again – **we recommend restarting the machine to complete the cycle and drain the sump.**

Starting a Sterilise and Dry Only Mode Without Washing

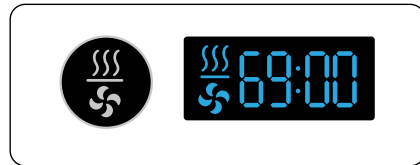

Sterilise & Dry: Touch the Sterilise-Dry button **1 time**, then press the Start/Pause button to start.

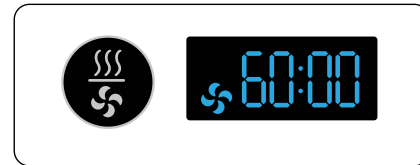

Dry Only: Touch the Sterilise-Dry button **2 times**, then press the Start/Pause button to start.

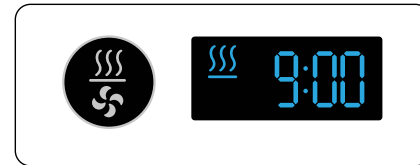

Sterilise Only: Touch the Sterilise-Dry button **3 times**, then press the Start/Pause button to start.

The Bottle Washer Pro® will shut-off automatically after finishing the Sterilise and Dry cycles.

 The Bottle Washer Pro® uses **HOT WATER, STEAM & HOT AIR** to wash, sterilise & dry bottles and accessories. **USE CAUTION** when handling bottles after washing, sterilising and/or drying.

Empty the Waste Water Tank after Wash/Dry cycle is complete

 Water in Waste Water Tank will be **HOT**. Always allow cooling time before handling Waste Water Tank.



Grip the handle on the back of the Waste Water tank and carefully remove it by sliding back.

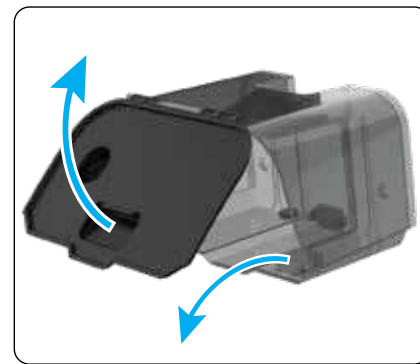

Gently lift lid and carefully pour waste water into sink.

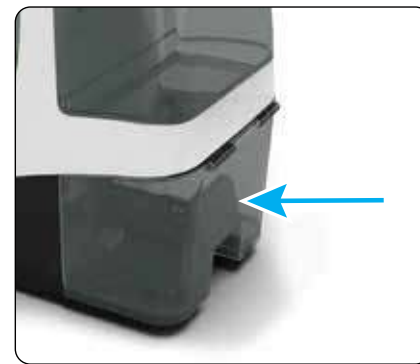

Rinse and Dry Waste water tank. Then insert it fully into the base of the Bottle Washer Pro®.

Cleaning the Bottle Washer Pro®

- Always unplug the Bottle Washer Pro® before cleaning.
- Do not immerse the base or power cord in water or other liquids.
- Do not clean base under water tap.
- Use a soft damp cloth to clean the base and control panel.
- Never use solvents, cleaning products, or abrasive pads to clean the plastic parts of the machine as they may damage the appliance and surface of the base.
- The top cover, bottom rack, and top rack can be cleaned in hot soapy water.
- To clean the intake filter, lift it with the handle and wipe any residue from the mesh.
- If Spray Jets become blocked, disassemble the top and bottom spray jets and centre tube, poke spray jet holes with a toothpick or small brush and rinse with warm soapy water.
- NEVER PLACE PARTS IN DISHWASHER, MICROWAVE OR STERILISER.

For Homes With Hard Water/Well Water

If your home has hard water/well water, mineral residue may be left on products after drying due to the high mineral content. To prevent this, we recommend using a water softener or distilled water.

Descaling the Bottle Washer



The Descaling Reminder will turn on after 20 washes to remind you to descale the heater plate. Press & hold the “Wash Mode” button for 5 seconds to clear the descaling reminder.

NOTE: If you have hard water, you may need to descale more often.

Descaling Instructions:

- To remove mineral scale from the heating plate, pour a mixture of 1 cup white (or distilled) vinegar and 1 cup water into the sump. Let mixture sit overnight.
- Fill the Clean Water Tank to FILL line with distilled water and run one “Wash Only” cycle to rinse the system, then dispose of the waste water.
- The stainless steel heating plate can be gently scrubbed with a scouring pad to remove any remaining mineral scale.

Replacing the HEPA filter - Recommended every 3 months

- First turn the Bottle Washer on its side to access the HEPA filter which is located on the bottom of the Bottle Washer Pro®. NOTE: some residual water may spill from sump
- Remove the filter cover by pressing the filter cover tab and lifting up.
- Remove the HEPA filter by pulling the filter tab and throw away the used filter.
- Install the new HEPA filter with the tab facing up.
- Replace the filter cover by inserting tabs and clicking the latch in place.

Replacement HEPA filters can be purchased at babybrezza.co.uk

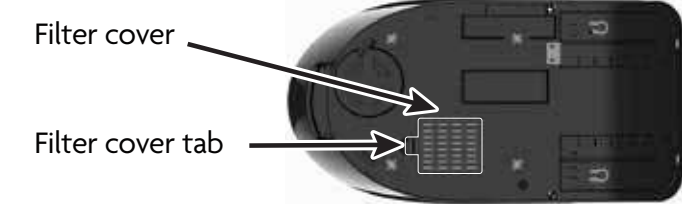
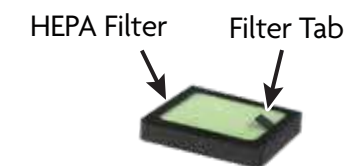







Bottom of Bottle Washer













Tips for best use

- Always load nipples facing up so water does not collect inside.
- When placing bottles or accessories in the washer, make sure water can run off the items and won't collect in product indentations. Example: don't place bottles/cups right side up or they will fill with water.
- Some bottles have concave bases and some nipples have outside flanges which can collect water. It's normal to see a small amount of water on the bottom even after drying like a glass in your dishwasher. Just tilt the product before removing so the water runs off in the machine.
- Always use Baby Brezza detergent tablets - see page 6 and visit babybrezza.co.uk for more info.
- **DO NOT USE any type of liquid, powder or pod detergent for your household dishwasher. These detergents are not properly sized for the Bottle Washer Pro and will create too much foam & leave detergent residue on your products.**
- If you need to discharge all water from the sump, press and hold the “Wash Mode” and “Sterilize/Dry” buttons for 3 seconds and the discharge pump will pump water from the sump to the waste water tank.

Troubleshooting

Condition	Possible Cause	Remedy
Bottle Washer will not start.	Unit is unplugged.	Make sure the plug is securely inserted into the power outlet.
	Unit is not turned on.	Touch power button on control panel.
	Not enough water in clean water tank.	Add water to FILL line of water tank.
Mineral Scale or Discoloring on Heating Plate	Mineral rich water used persistently.	Clean heater plate after each use.
	Bottles not rinsed before placed in Bottle Washer causing milk residue to burn on heating plate	Rinse all bottles & accessories before placing in the Bottle Washer Pro®
	Clean Water Tank is not properly assembled on base.	Make sure Clean Water Tank is seated all the way on the base.
	Waste Water Tank is not properly assembled on base.	Make sure Waste Water Tank is seated all the way on the base.
	Clean Water Tank is low or empty.	Refill Clean Water Tank to the FILL line.
	Waste Water Tank is full or holds too much water.	Empty Waste Water Tank.
	Washer Lid is not completely closed or not seated properly.	Make sure lid is seated completely on the base.
	Descaling is necessary.	Follow instructions on page 8 to descale the heating plate. Press and hold "wash mode" button for 5 seconds to clear descaling reminder
Spray Jets have low pressure	Spray Jets are physically blocked by items in the wash chamber.	Make sure bottles / accessories are centred over Spray Jets and are not blocking holes on jets. Make sure top and bottom racks are placed correctly on base.
	Spray Jet holes are blocked with debris.	Clean jets with brush, small pointed tool or toothpick. See cleaning detail on page 8.
	Spray Jet fixture is not properly assembled.	Make sure all fittings on spray jet fixtures are assembled properly.
	Spray Jet fixture is broken or cracked.	Inspect spray arms for damage and Contact Baby Brezza Customer Care for replacement parts.

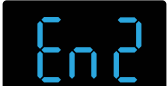
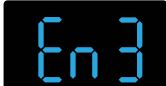
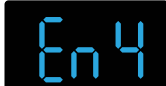
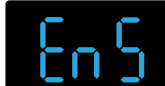
Troubleshooting Continued

Condition	Possible Cause	Remedy
Bottles and/or top rack items not dry.	Nipples or parts placed upside-down on top rack collect excess water. Indentations on bottom of some bottle and nipple types collect excess water.	Always place nipples & parts in proper position to eliminate collecting or pooling of water. An extra dry cycle may be needed for bottles & nipples with deep indentations.
Excessive soap bubbles, foam in wash compartment or film on bottles and parts	Wrong type of detergent/soap used.	Only use Baby Brezza Detergent tablets with Bottle Washer. NEVER USE any detergent type for your household dishwasher. NEVER USE liquid foaming detergent
	Too much detergent used.	Only use 1 Baby Brezza Detergent Tablet per wash cycle
	Water has run out during Sterilisation cycle.	Add water to FILL line and restart Sterilisation cycle.
	Error code E5 - If the machine is stopped or loses power when washing and the sump is full, "E5" will be displayed on the LCD. To clear the code, you will need to discharge all water from the sump by touching and holding the "Wash Mode" and "Sterilise/Dry" buttons for 3 seconds. The discharge pump will pump water from the sump to the waste water tank.	
Error codes - If any of the codes below appear on the LCD screen, please contact Baby Brezza Customer Care.		
		
		
		
		
		

If you can not remedy problems by using the troubleshooting chart above, do not return your Bottle Washer Pro® to the store. Please visit babybrezza.co.uk for videos and assistance.