

Axkid Nextkid

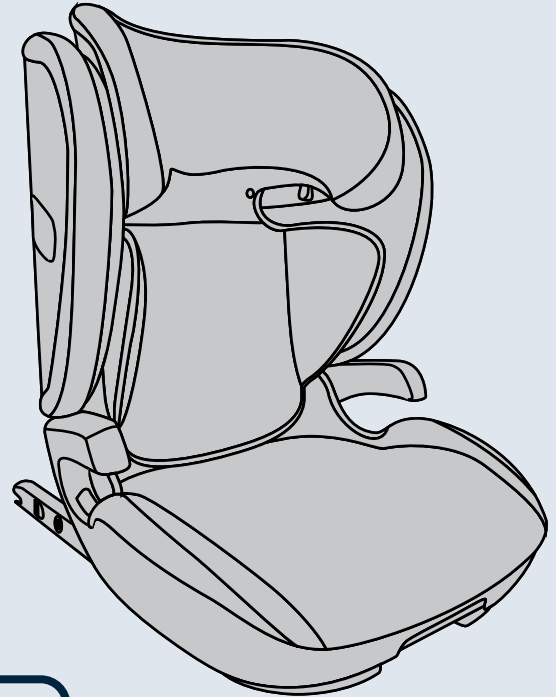

UN regulation no. R129
Instruction Manual
100-150cm, Gr 2-3

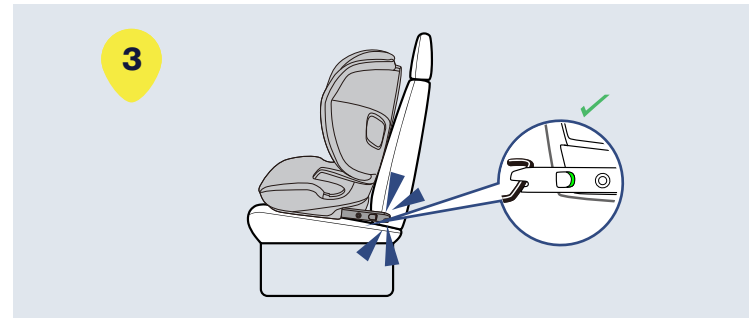

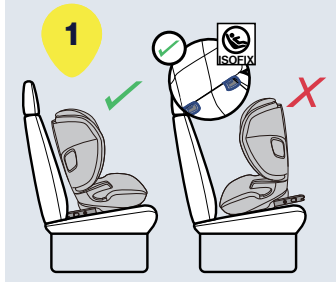

5

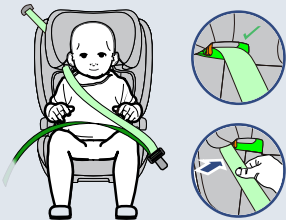

6



7

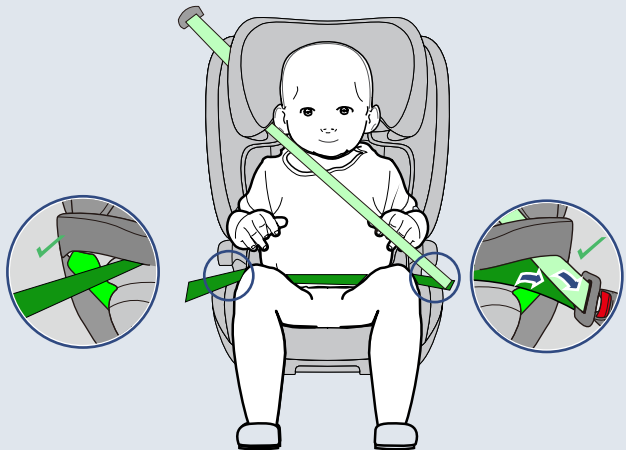

8

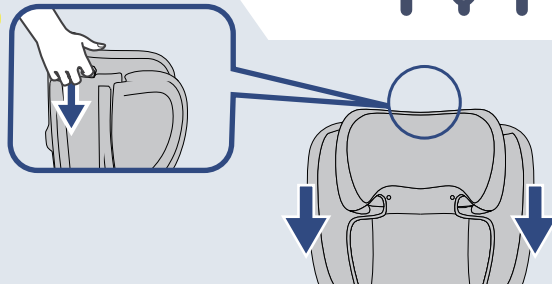

10

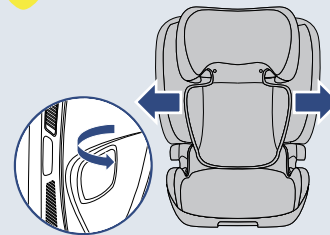

11

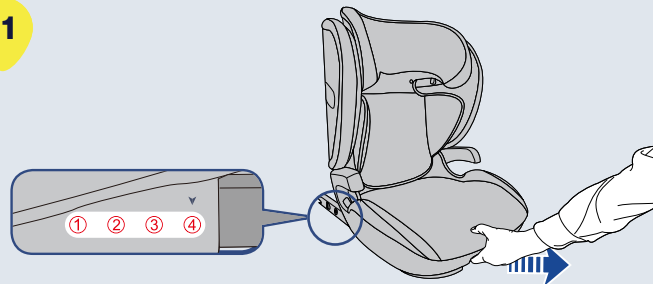

Sverige/Norge

Axkid AB
www.axkid.com
info@axkid.com
Tel: (+46) 511 760 620

UK/Ireland

Axkid Ltd
www.axkid.com
info@axkid.com
Tel: (+46) 0511 – 760 620

France

Axkid AB
www.axkid.com
info@axkid.com
Tel: (+33) 06 07 01 87 73

Deutschland

Axkid GmbH
www.axkid.com
kundenservice@axkid.com
Tel: (+49) 60-99 84 89 05

España/Portugal

Independent Marketing
www.infobebe.es
info@infobebe.es
(+34) 952 561 000

Polsce

Junior Andrzej Kwapinski
Horbaczewskiego 4-6
54-130 Wrocław Dł Astrą Sklep
Poland Tel: (+48) 713 549 723

Czech Republic

Domecek pro deti
www.domecekprodeti.cz
info@domecekprodeti.cz
(+42) 0727 981 815

România

SC Baby Car seats
www.axkid.ro
maria@axkid.ro
(+40) 0747 35 47 47

New Zealand

Clicksafe
www.clicksafe.co.nz/axkid
axkid@clicksafe.co.nz
Tel: (+64) 212 504 215

Suomi

Lastentarvike
www.lastentarvike.fi
info@lastentarvike.fi
(+358) 09 852 05 100

Malaysia

SafenSound
www.safensound.com.my
may@safensound.com.my
(+60) 358 70 22 84

**Greece Ελλάδα
Serbia Србија**

LETO shop
www.letoshop.gr
christos@letoshop.gr
(+30) 211 102 67 90

Eesti

GreenHansa OÜ
www.beebipood.ee
riho@beebipood.ee
(+372) 5300 8000

Latvia

Muki
www.muki.lv
jurgis@muki.lv
(+371) 292 828 98

Lietuva

Kotryna Group
www.kotrynagroup.com
kotryna@kotryna.lt
(+370) 521 322 54

South Africa

Quality Imports SA & #Carseatfullstop
www.qualityimportssa.co.za
qualityimportssa@gmail.com
(+27) 11 789 7119

Ísland

Leiftur
www.leifturis
kristmann@leifturis
(+354) 821 25 37

EN

6-11

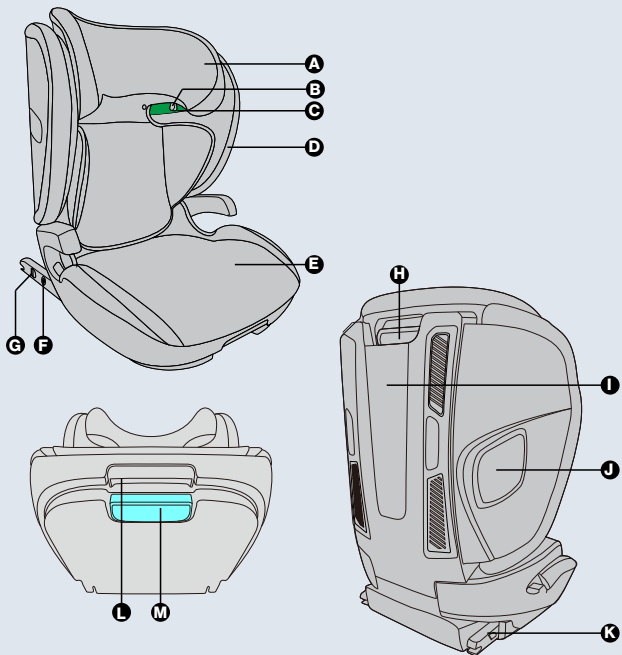

A	Head rest	H	Headrestheight adjustinghandle
B	Shoulder strap guide hook Unlocking part	I	Backrest
C	Shoulder strap guide hook	J	SIP Bumper Controller
D	Side wings	K	ISOFIX
E	Base	L	Angle adjustment handle
F	ISOFIX unlocking device	M	ISOFIX release handle
G	ISOFIX dual locking button		

Parts	6
Important information	7
Product description	8
Allowed and disallowed positions	9
Installing the car seat in the vehicle	9
Restraining your child	10
Seat adjustment	10
Removing the car seat from your vehicle	11
Care and maintenance	11
Warranty	11

Thank you for choosing Axkid Nextkid

Read this instruction manual before installing Axkid NextKid car seat in your vehicle. For more information and installation videos visit www.axkid.com.

Axkid Nextkid is a forward-facing car seat approved for children between 15 to 36 kg and is approved according to ECE R129

If in doubt, contact your retailer who can demonstrate a correct installation. An incorrect installation could endanger your child.

Important information

To maximize your child's safety, it is important that you keep the following in mind:

- The seat is **ONLY** to be used forward facing and for children weighing between 15 and 36kg.
- The child should be a minimum of 140 cm in height to sit in front of an active airbag unless there are other recommendations from the car manufacturer. If you still wish to install the seat in such seating position the airbag must be switched off according to the vehicle manufacturers instructions.
- Should you have an accident, no matter how small, your child car seat should always be replaced. It may have damage that is undetectable and could seriously jeopardize your child's safety. For this reason, Axkid does not recommend purchasing secondhand child car seats.
- **DO NOT** use anything such as a cushion or coat to raise the child car seat off the passenger seat. In the event of an accident, the child car seat and the vehicle seat belts will not be able to protect your child as well as they should.
- Avoid placing your child in direct sunlight for extended periods of time to avoid risk of the child overheating.
- Never leave your child unattended in the car.
- Ensure any luggage or loose objects are secured in your vehicle as they may cause injuries to passengers in the event of a collision.
- Ensure that the child car seat does not become trapped by any moveable seats or doors within the vehicle. To prevent injury due to deterioration, discontinue using a child seat if it is older than 8 years or has been in a crash.
- All passengers must be secured in their seats using a safety belt.
- Read this instruction manual before installing the child car seat in your vehicle. For more information and installation videos visit www.axkid.com. Keep this instruction manual for future reference.

- DO NOT attempt use any part of this child car seat with any other child car seat.
- DO NOT (except where described in this manual), attempt to disassemble or modify this child car seat or change the way the vehicle's seat belts are used.
- DO NOT use the child car seat in the home, or any other non-certified location. It has only been designed to be used in a car.
- Ensure that The child car seat is always secured to the vehicle car seat - even when not in use. The child car seat must not be used without the textile cover.

Product Description

Product	Group	Installation	Type
Nextkid	100cm-135cm	3-point Belt/ ISOFIX+3-point Belt	Universal
Nextkid	135cm-150cm	3-point Belt/ ISOFIX+3-point Belt	Special vehicle

Allowed and disallowed positions

The Axxid Nextkid can be used on any forward-facing passenger seat which has a 3-point seat belt, approved to UN/VECE Regulation No. 16 or other equivalent standard. The Axxid Nextkid cannot be used with a 2-point lap belt.

Front passenger seat (no active airbag)	YES
Front passenger seat (active airbag)	NO*
Forward-facing seat with 3-point safety belt	YES
Seat with 2-point safety belt	NO
Side-facing seats	NO
Rear-facing seats	NO

IMPORTANT: The child should be a minimum of 140 cm in height to sit in front of an active airbag unless there are other recommendations from the car manufacturer. If you still wish to install Axxid Nextkid in such seating position the airbag must be switched off according to the vehicle manufacturer's instructions. It is important to always check if the vehicle's indicator light shows that the airbag is turned off.

IMPORTANT: Never use on rearward or side facing vehicle seats.

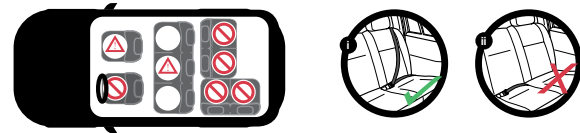

Installing the car seat in the vehicle

1. Place the child car seat in a suitable forward-facing position equipped ISOFIX connection points. If the vehicle's seat back is adjustable, ensure it is in the upright position.
2. Extend the ISOFIX release handle (M) by pushing the ISOFIX adjustment handle (K) and extending the sliders
3. Insert the ISOFIX connectors (K) to the ISOFIX connection point in the car. Make sure that there is a "click" sound and a green indication on both ISOFIX indicators (G).
4. Push the child car seat towards the vehicle seat back until there is no space between the vehicle seat back and the child car seat.

IMPORTANT: When the ISOFIX unlock button is displayed in green, the ISOFIX is in the locked state, and when it is displayed in red, it is in the unlocked state. When unlocking, press and hold the two lock buttons while pulling the ISOFIX unlocking piece backwards to complete the unlocking.

Restraining your child

- Place your child in the child car seat and pull the shoulder strap through the green shoulder strap guide (C).
- Move the belt in front of the child to the vehicle belt buckle. Insert the seat belt into the vehicle belt buckle and make sure that you hear a click.
- Pass the lap belt through the green lap belt side guide.

WEIGHT: Tighten the strap in the protruding area and check the taut fit.

Seat adjustment

- Pull the Headrest Adjusting Handle (H) upward to proper height, making sure the Shoulder Belt is level with your child's shoulder.
- The correct height of the headrest is when there is 1 cm between the child's shoulder and the lower edge of the headrest (A). Once the right fit is found release the handle and check the headrest to ensure it is locked into position.
- Pull the SIP Bumper Controller (J) to unlock and pull outward or push inward then you can make different sized according to Car's internal Situation. It can also be adjusted on one side.
- Pull out the angle adjusting handle (L) on the front of the seat, meanwhile move the back of the seat to different angles. Adjust the seat into proper angle before fastening the belt on the child. (there are 4 positions.)

IMPORTANT: NEVER place your child in the Axkid Nextkid whilst it is not fitted in a car, The car seat should never be used free-standing as it may tip backwards.

IMPORTANT: The lap belt is worn low over the hips. Check that the lap belt passes through both green lap belt side guides. Check that the shoulder belt passes through the green shoulder belt guide (C) diagonally across the child's chest and through the green lap belt side guide nearest to the seat belt buckle. Finally, check that all slack has been removed from the vehicle seat belt.

IMPORTANT: Make sure the seat belt buckle is not wedged or interfering with the lap belt side guides.

WARNING: An unoccupied the Axkid Nextkid should be secured using a 3-point seat belt or the ISOFIX connectors if available.

IMPORTANT: DO NOT recline the child seat's backrest beyond the allowable adjustable range. If you hear a loud "click" whilst adjusting the backrest, then you have gone past the allowable range. Reclining the vehicle seat may adversely affect the position of the vehicle seat belt across the child and may result in death or serious injury during a crash. Refer to your vehicle owner's manual for adjusting the vehicle seat back with child seats.

Removing the car seat from your vehicle

To remove the Axkid Nextkid from the vehicle, press both ISOFIX buttons to release the Axkid Nextkid from the ISOFIX connection points (F) and lift the seat out of the vehicle. To remove the ASIP, push the button on the ASIP and remove.

Care and maintenance

- The Axkid Nextkid cover can be removed and washed in a washing machine at 30°C on the "Gentle Cycle" program. Do not put the cover in a dryer as this can damage the cover and the padding may separate from the fabric.
- Removing and refitting the seat covers.
 - Raise the headrest to its highest position to allow for more room to work.
 - Pull out the snap-fastener of the base cover and then pull down the base cover.
 - Pull out the cover of SIP Bumper from the rim of the seat and tear apart the macro tape.
 - Get the rope out of the hook, pull the cover of the Shoulder Guide out and then pull the whole headrest cover out.
 - Visit www.axkid.com to find videos explaining how to remove and attach the cover.
- Any plastic parts of Axkid Nextkid can be cleaned with mild detergent and water. Do not use aggressive chemicals containing solvents etc., as this can cause damage to the plastic and compromise the safety of the car seat.
- Do not make any modifications or alterations to Axkid Nextkid other than those described in this instruction manual. Follow the instructions in this manual carefully. Any repairs must be carried out by the manufacturer or agent.
- If the seat cover needs replacing, ensure only original products from Axkid are used. If other products are used, the car seat safety system may be compromised and could lead to severe injury in case of an accident.

Recycling your base



Axkid strongly recommends recycling of old car seats. Before leaving the base at your local recycling station separate metal and plastic parts if possible. The main part of the base should be marked unsafe or expired (use a marker) to deter anyone from using it again. Please check your local municipal guidelines for recycling instructions for the different materials.

Warranty

Axkid Nextkid is covered by a 24-month warranty from date of purchase. Ensure you save your receipt and bring it to your place of purchase if you have any warranty issues.

The warranty does not cover:

- Normal wear and tear
- Damage due to incorrect use, neglect, or accident
- If repairs have been carried out by a third party
- All materials used have a very high UV-resistance rating. However, UV-light is very aggressive and will ultimately lead to fading of the seat cover. This is not covered by our warranty as it is considered normal wear and tear.