



# MB200

## 2-in-1 Travel System

**GB** Instruction Manual

**ES** Manual de instrucciones



**IMPORTANT, RETAIN FOR FUTURE REFERENCE: READ CAREFULLY**

# Welcome to the familiee

Your trust in our product means the world to us, and we're thrilled to be a part of your parenting journey. Our team has worked tirelessly to ensure that the product provides comfort, safety, and style for you and your little one. We're confident it will exceed your expectations. Should you have any questions or require assistance in the future, please don't hesitate to reach out. Thank you for choosing My Babiie; we wish you and your family countless wonderful strolls ahead.

## Get to know your MB200 2-in-1 Travel System

Scan the QR code below on your camera app to be linked off to our page to get all the information you need for using your Travel System. From setting it up to how to fold it down, it's all there!



# Warranty

---

We provide a 1 year warranty against manufacturing or material defects. The warranty period is effective from the day of purchase and applicable to the UK and Ireland. If you made your purchase from an authorised retailer, please return your product to them.

If you bought your product via our website; mybabiie.com, please contact our Customer Service team via email (info@mybabiie.com). We are happy to refund any product if you change your mind about your purchase (if purchased from our website, mybabiie.com.) As long as you tell us within 30 days of receiving your goods. They must be returned in an unused condition, in the original, undamaged packaging and complete with all original parts and accessories. Proof of purchase is required.

What is not covered by the Guarantee?

- Failure to follow My Babiie user guide and maintenance instructions.
- Damage caused by non domestic use
- General wear and tear, for example: worn wheels, damaged rain covers, worn/tear fabric.
- Deliberate damage, misuse or neglect.
- Product which has been modified, undergone an unauthorised repair or used a non approved spare part.
- Cosmetic damage.
- Parts subject to normal wear and tear, foam handles, rubber elements of wheels, signs of fabric wear.
- Loss incurred as a result of not being able to use a product whilst waiting for a spare part or repair.

A repair service is available for any item that sustains accidental damage at any point during its lifespan. If the damages are not covered by our guarantee, we will provide a quote for the repair costs on an individual basis. If you find yourself in need of spare parts that are not covered by the warranty, you can purchase each spare part on our website (subject to availability).

To read more about your guarantee, please visit [mybabiie.com/guarantee](http://mybabiie.com/guarantee).

Our guarantee is provided by My Babiie Ltd, Registered address: 15 Commercial Road, Paddock Wood, Kent, TN12 6EN .

Your statutory rights are not affected by the guarantee.

Registering your Warranty

To register your warranty please visit [www.mybabiie.com/warranties](http://www.mybabiie.com/warranties)

Registering for your product warranty allows you to claim repairs or replacements if your product develops a fault. It will also help us contact you in the event of a product issue that you may need to be made aware of.

Problems or Questions

If you have any questions about your product then please drop us an email at [info@mybabiie.com](mailto:info@mybabiie.com) and we will get back to to you as soon as possible. Alternatively, you can chat to us on our Live Support Chat on our website [mybabiie.com](http://mybabiie.com) or contact us via our social media channels.

1

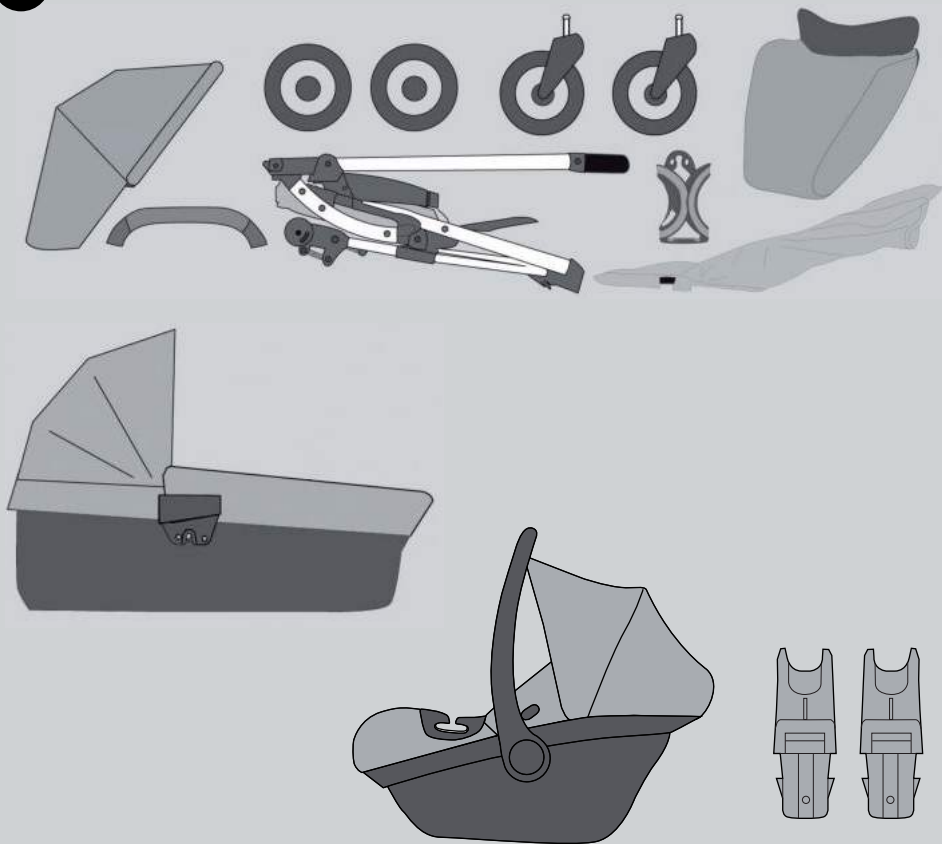

2a

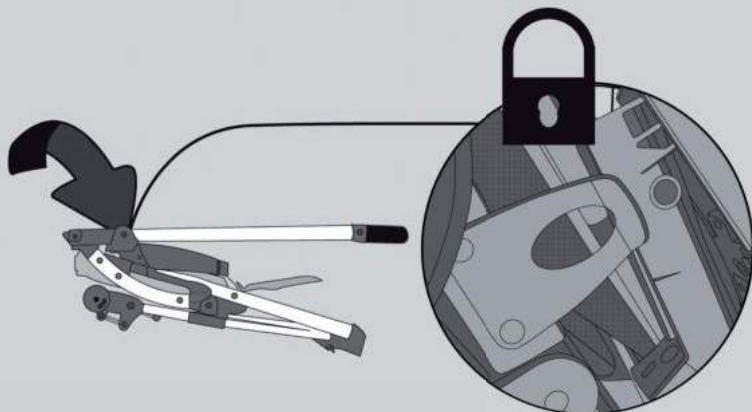

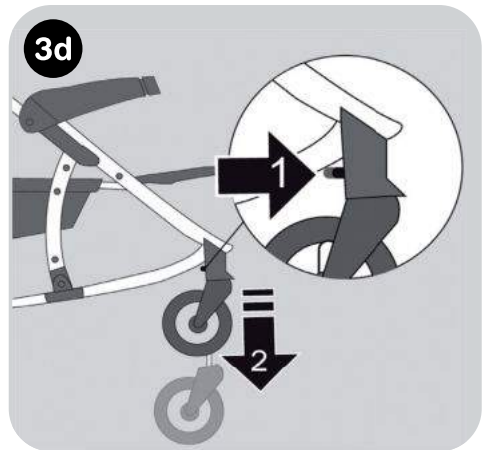
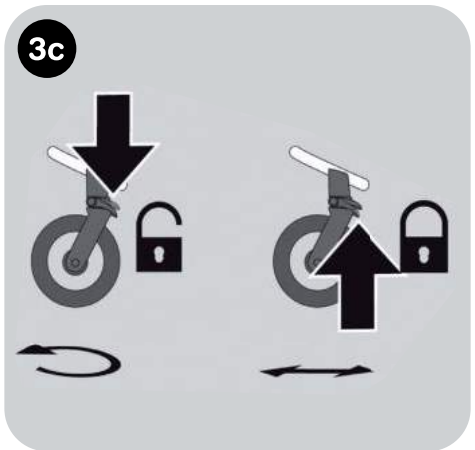
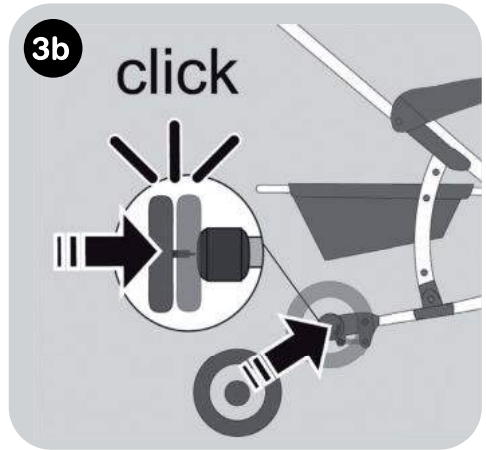
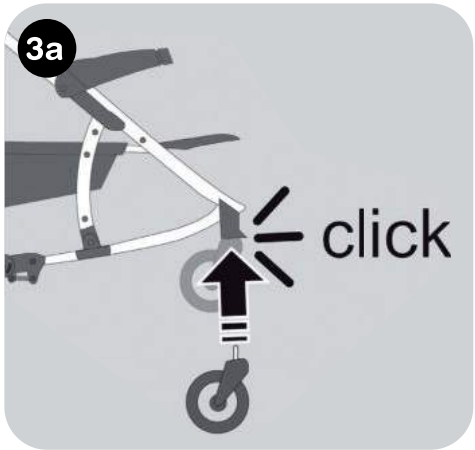

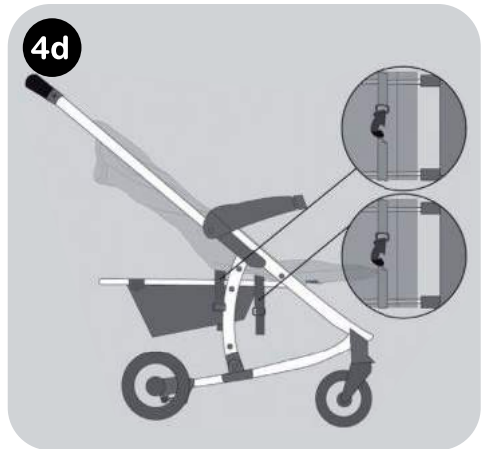
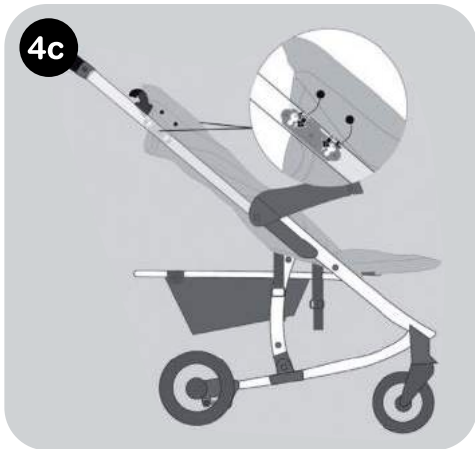
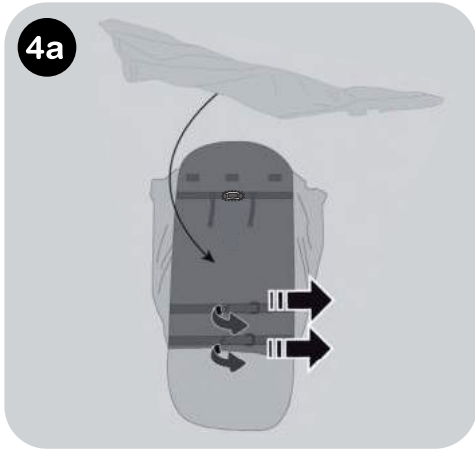
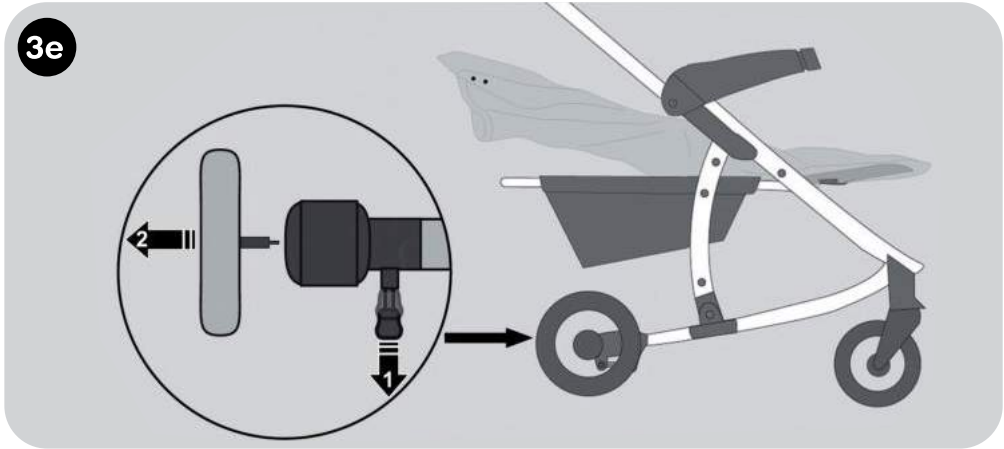

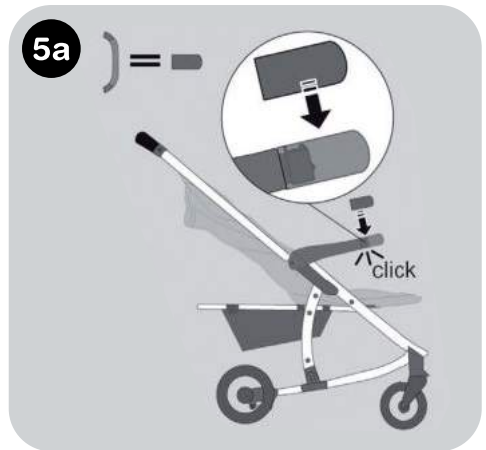
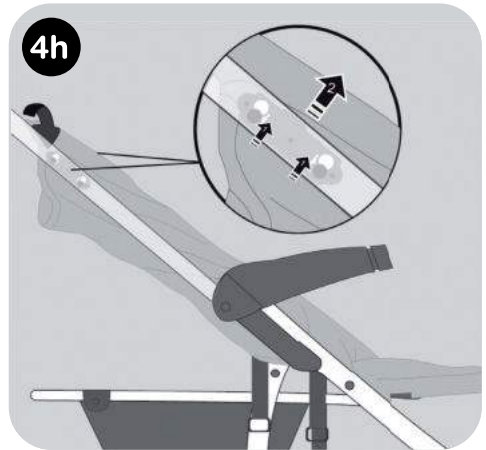
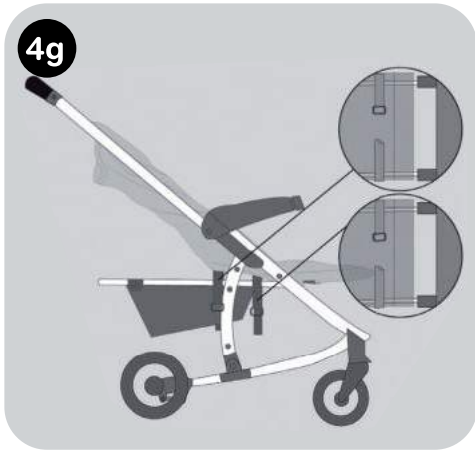
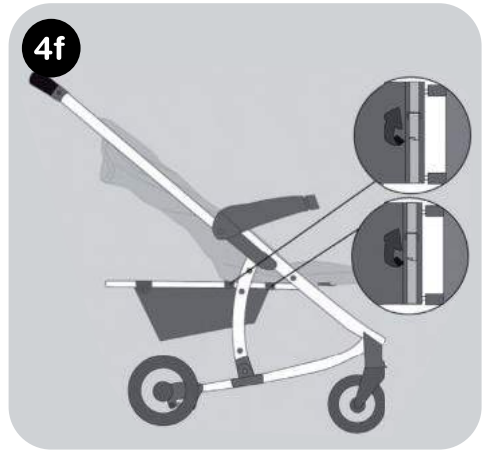
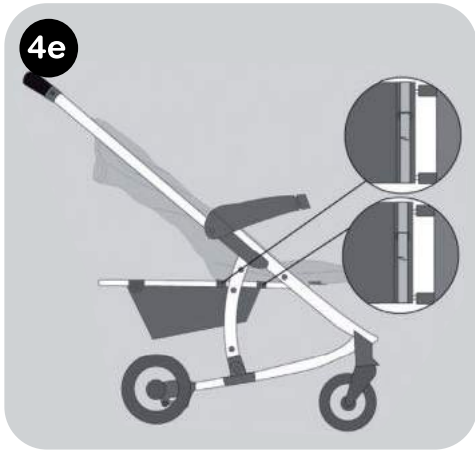

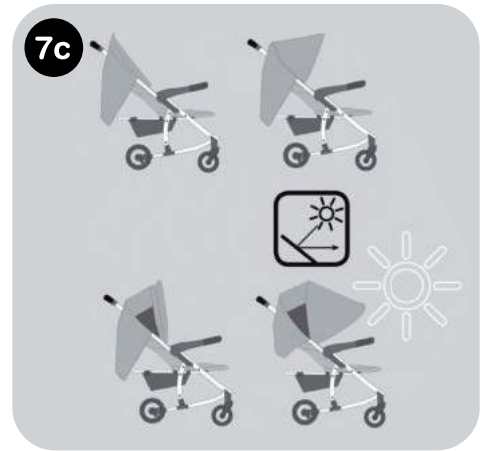
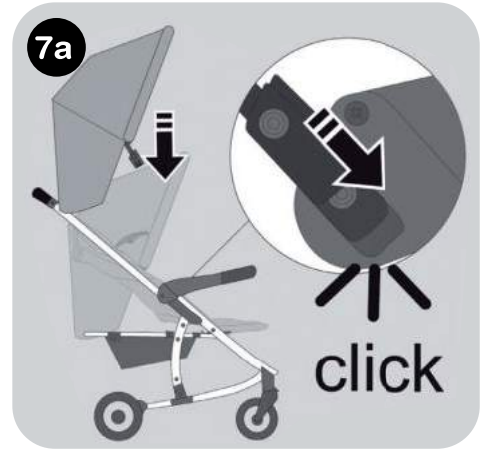
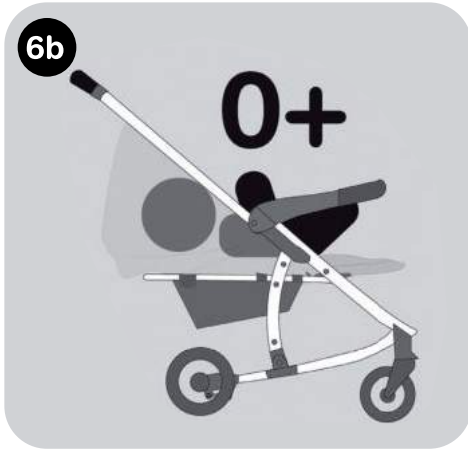
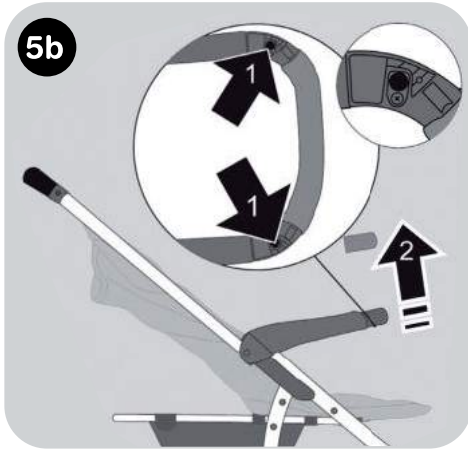

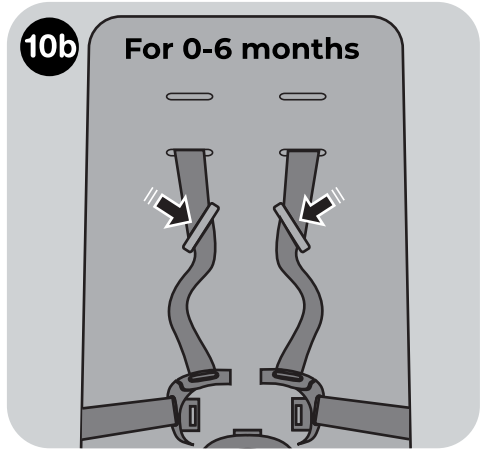
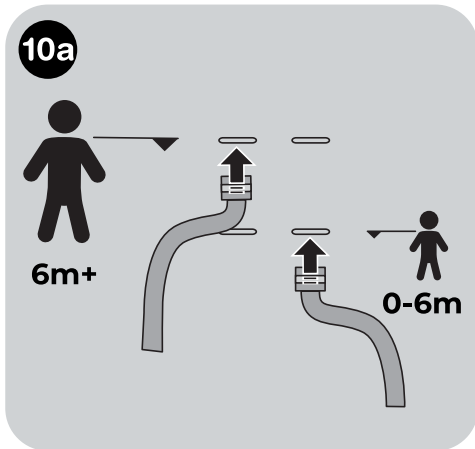
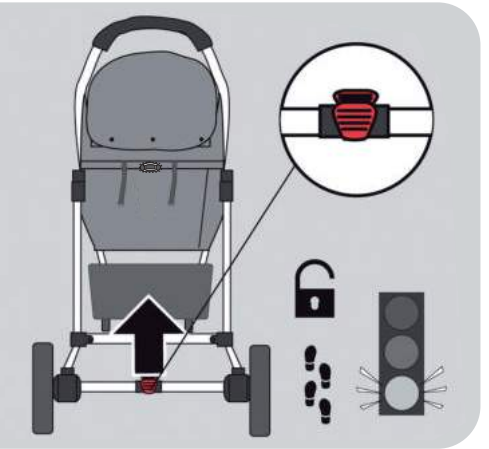
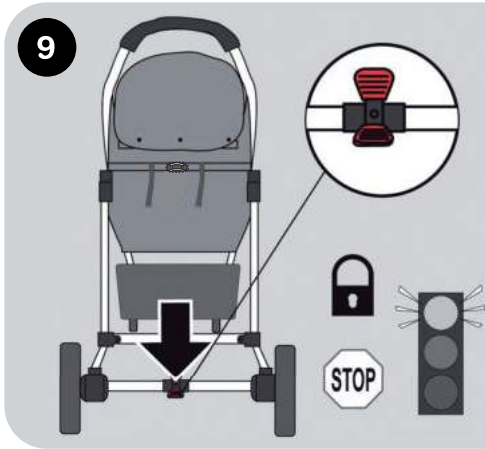
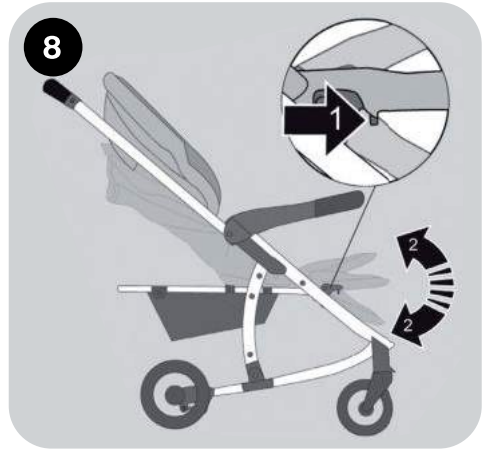

10c

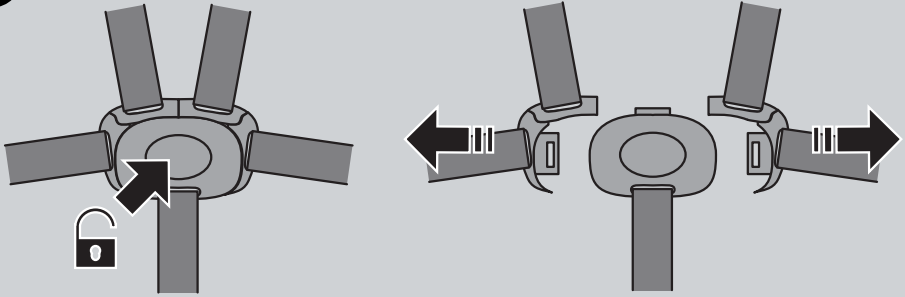

11a

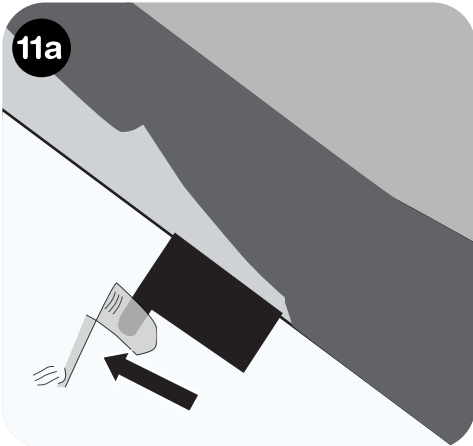

11b



12

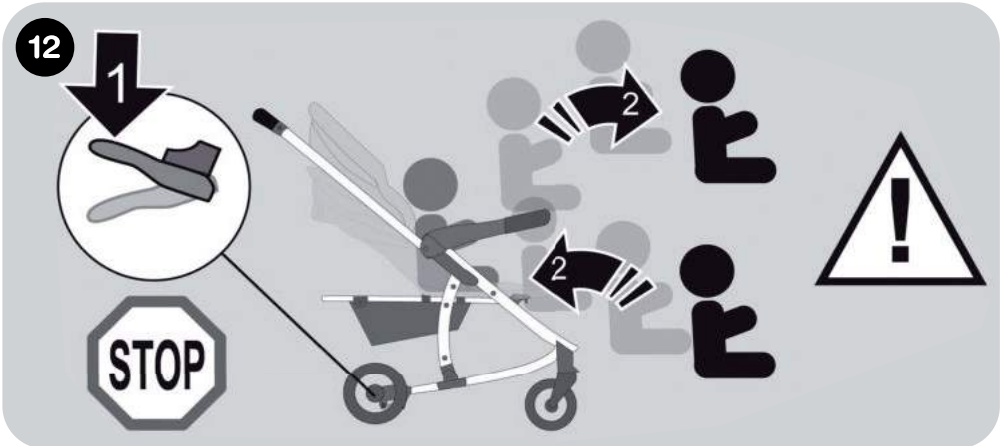

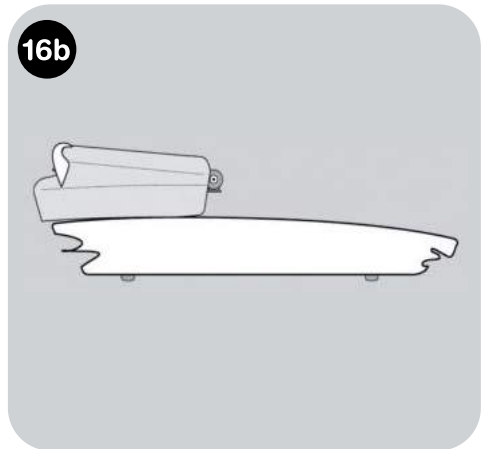
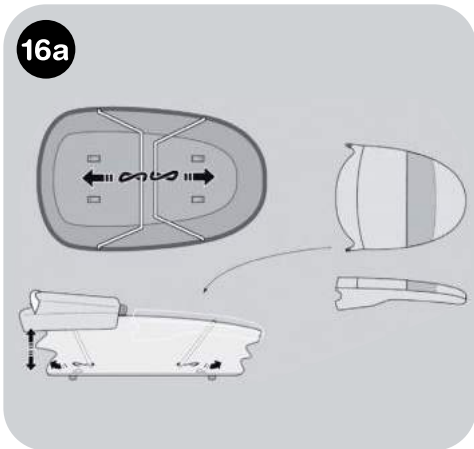
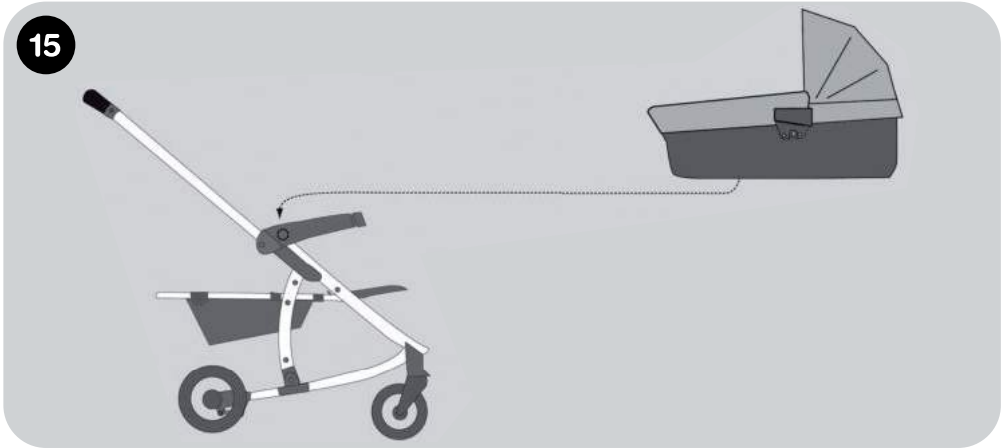
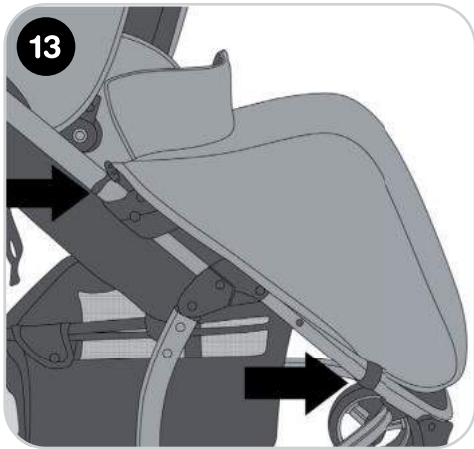

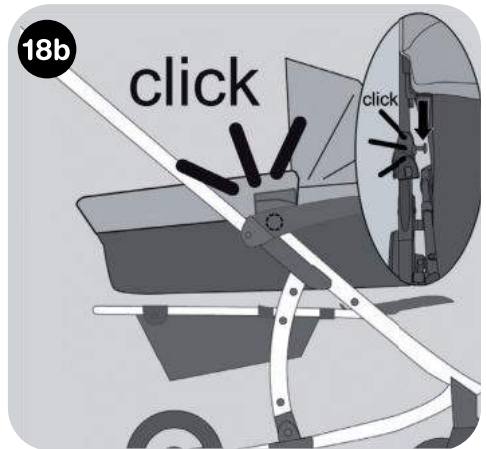
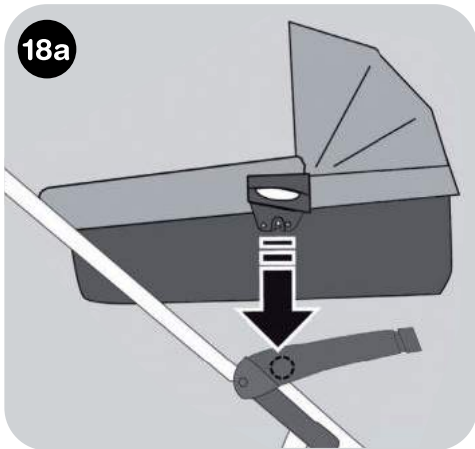
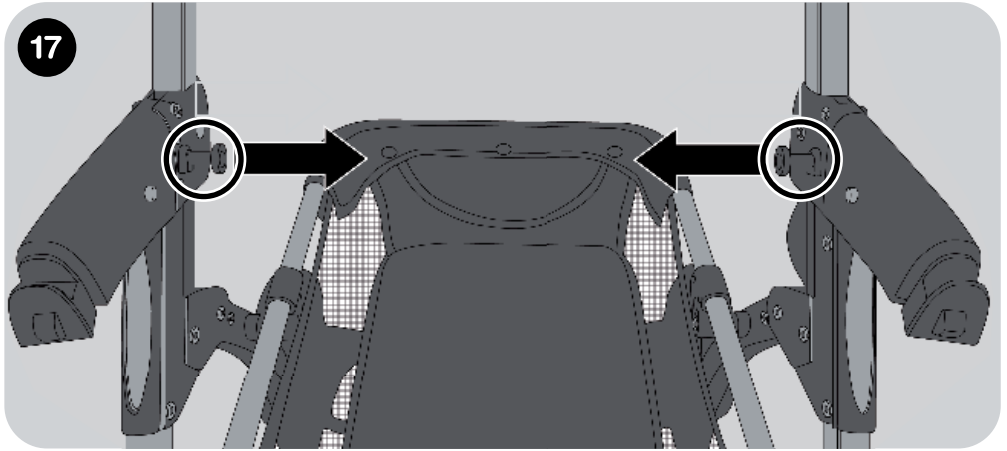
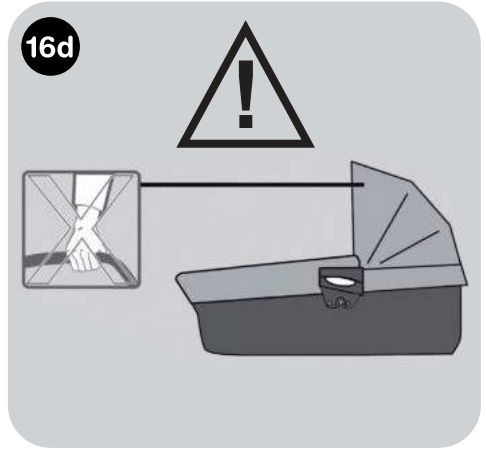
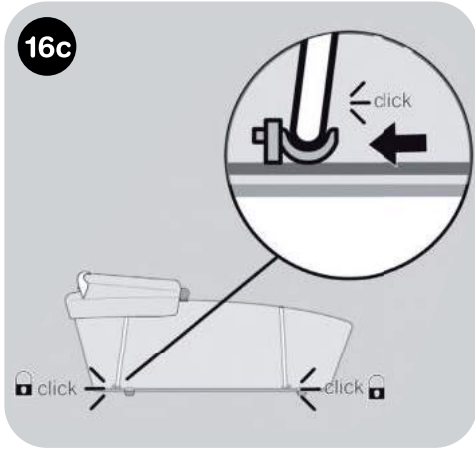

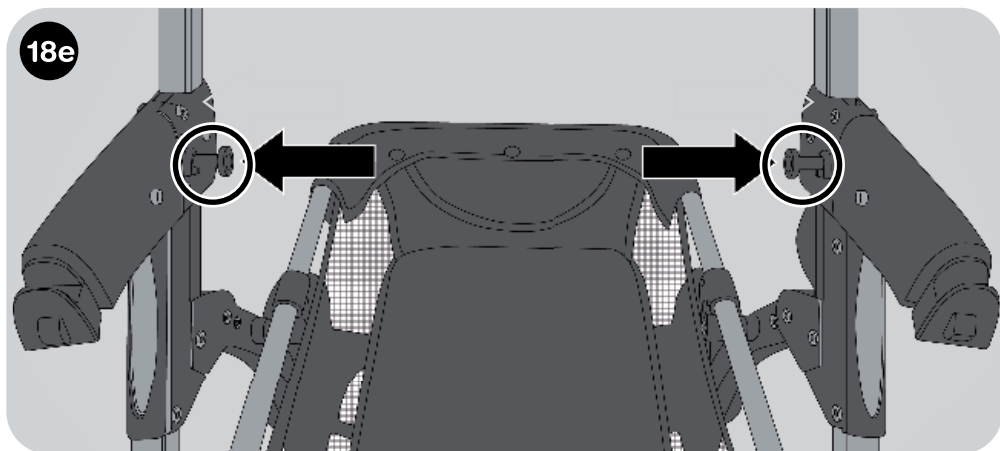
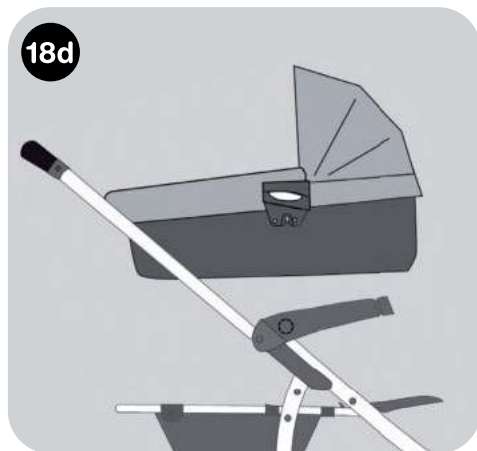
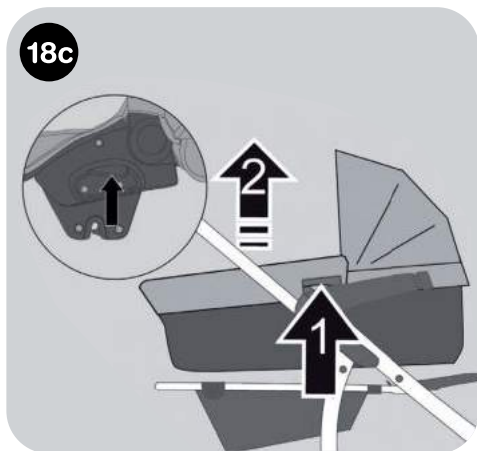

**20a** Car Seat sold separately

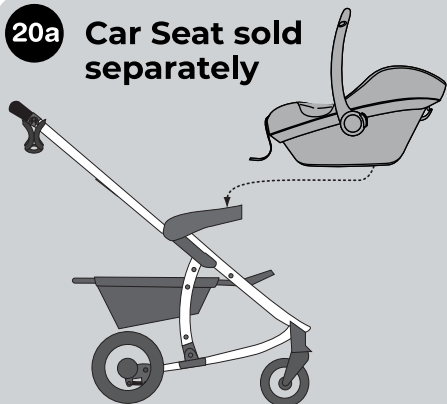

**20b**

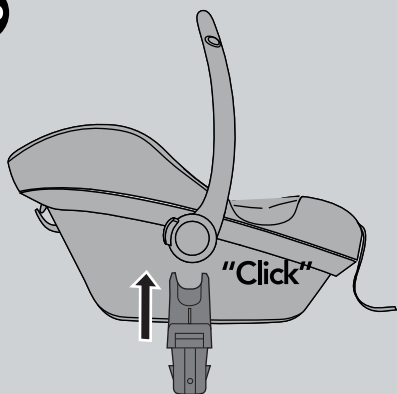

**20c**

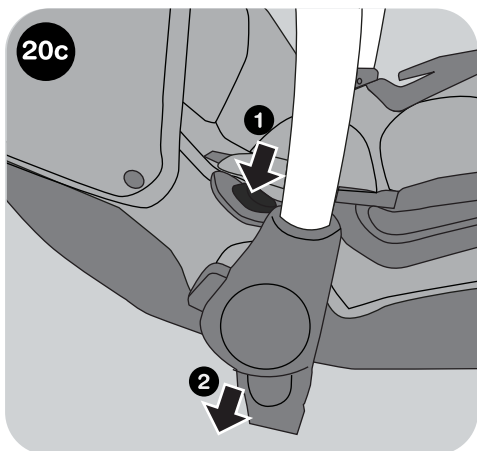

**20d**

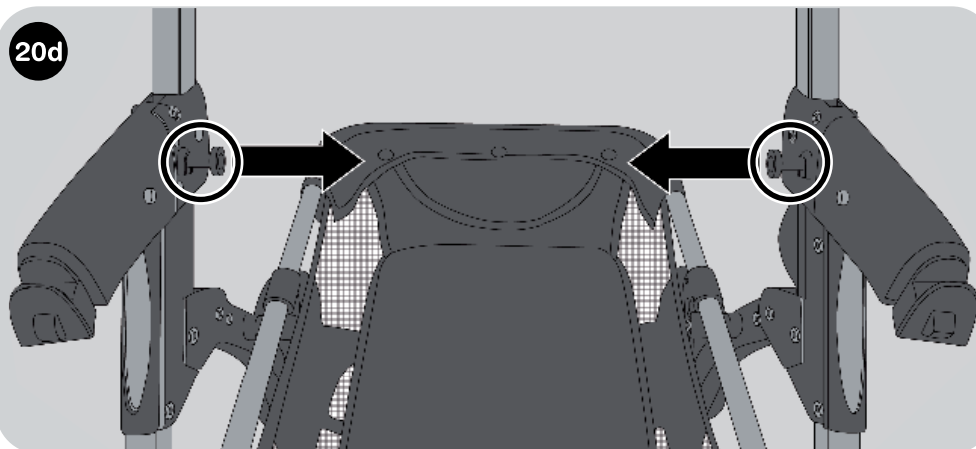

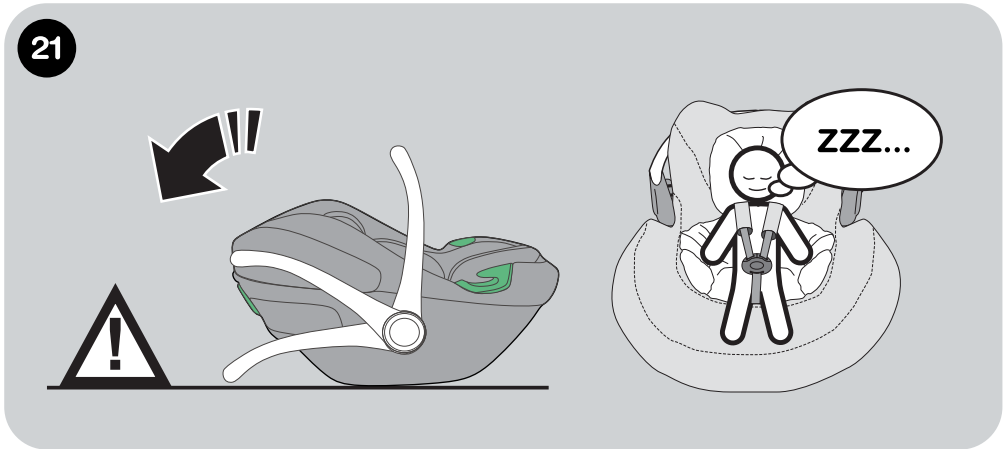
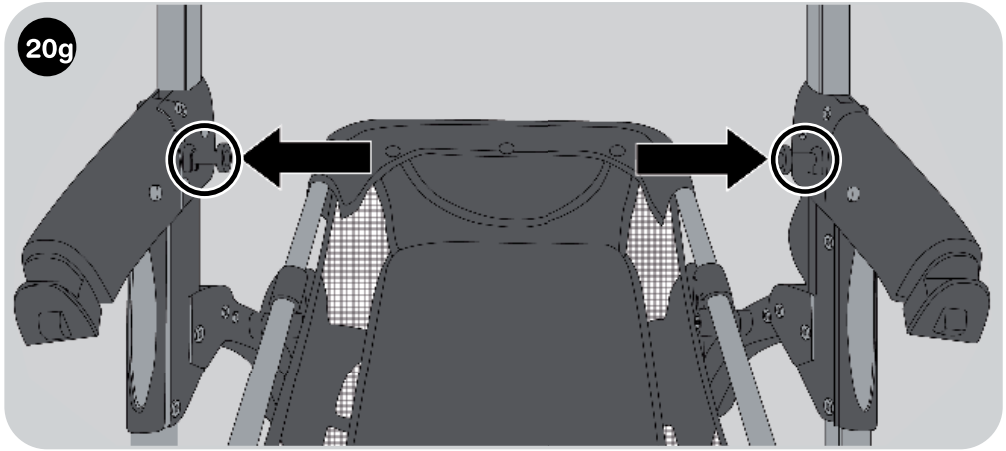

# Safety & Care Information

---

IMPORTANT, RETAIN FOR FUTURE REFERENCE:  
READ CAREFULLY

Please read these instructions carefully before use and keep them for later reference.

Remove all packaging and non-permanent labels and dispose of safely before using this product. The safety of your child could be put at risk if you do not follow these instructions.

This stroller is designed for 1 child from 0 months up to a weight of 22 kg/36 months.

**WARNING:** Never leave your child unattended.

**WARNING:** Uneven or excessive loading of items on or in the stroller may cause the product to tip and may cause injury.

**WARNING:** Maximum intended weight within the shopping basket is 3kg.

**WARNING:** Ensure that all the locking devices are engaged before use.

**WARNING:** To avoid injury ensure that your child is kept away when unfolding and folding this stroller.

**WARNING:** Do not let your child play with this stroller.

**WARNING:** Always use the restraint system.

**WARNING:** Check that the pram body or seat attachment devices are correctly engaged before use.

**WARNING:** Do not put hot drinks or liquids in the cup holder.

**WARNING:** This product is not suitable for running or skating.

**WARNING:** Do not insert any additional mattresses into the stroller.

**WARNING:** Accessories which are not approved by the manufacturer shall not be used.

**WARNING:** This pushchair has been designed for one child and shall be used for the transport for only one child!

**WARNING:** Always use the crotch strap in combination with the waist belt.

**WARNING:** This stroller does not replace a cot or a bed. Should your child need to sleep, then it should be placed in a suitable cot or bed.

**WARNING:** Only replacement parts supplied or recommended by My Babiie shall be used.

**WARNING:** Any load attached to the handle and on the back of the backrest and on the sides of the stroller will affect the stability of the stroller.

**WARNING:** The parking device shall be engaged when placing and removing the children.

**WARNING:** The carrycot should not be used as soon as the child is able to sit by themselves, roll over or can push itself up on its hands and knees. Maximum weight of the child: 9kg

EN1888-1&2:2018 Approved

# Carrycot warnings

---

- The product is only suitable for one (1) child.
- The product shall not be used as soon as the child is able to sit by himself, roll over and can push itself up on its hands and knees.
- Maximum weight of the child: 9kg.
- Do not add additional mattress.
- This product is compatible with the chassis of the stroller.
- Only use on a firm, horizontal level and dry surface.
- Do not let other children play unattended near the carry cot.
- Do not use if any part of the carry cot is broken, torn or missing.
- Do not leave flexible carrying handles inside the carry cot
- Never leave your child unattended.
- Only use original replacement parts. It may be unsafe to use substitutes.
- Be aware of the risks presented by an open fire and other heat sources such as electrical heaters, gas flames etc. especially if they are in the immediate vicinity of the carry cot.
- Only use the mattress supplied with the carry cot. Please check on a regular basis the carrying handle and the base including all feet for wear and damage of any kind.
- Never use the carry cot on a stand.
- Ensure that your child's head is never at a lower level than it's body when placed inside the carry cot.
- All carrying handles shall be left out of the pram body during use.

EN 1466:2023

## Care & Maintenance

---

- Please check on a regular basis that the brakes, wheels, latches, connecting elements, belt systems and seams are properly functional.
- Do not expose the stroller to strong sunshine.
- Sponge clean only.
- After use in rain or snow, the wheels should be lubricated and the stroller dried to prevent rust.
- Care for, clean and check this stroller regularly.
- Do not use accessories that have not been approved by the manufacturer.

Your child's safety is your responsibility

If you have a problem with this product or require replacement parts, please visit [www.mybabiie.com/support](http://www.mybabiie.com/support)

Register your product at: [www.mybabiie.com/warranties](http://www.mybabiie.com/warranties)

# Información de seguridad y cuidado

## **IMPORTANTE, CONSERVE PARA FUTURAS CONSULTAS: LEA CUIDADOSAMENTE**

Lea atentamente estas instrucciones antes de usarlas y consérvelas para consultarlas en el futuro.

Retire todos los embalajes y etiquetas no permanentes y deséchelos de forma segura antes de usar este producto. La seguridad de su hijo podría correr riesgo si no sigue estas instrucciones.

Este cochecito está diseñado para 1 niño desde 0 meses hasta un peso de 22 kg/36 meses.

**ADVERTENCIA:** Nunca deje a su hijo desatendido.

**ADVERTENCIA:** La carga desigual o excesiva de artículos sobre o dentro del cochecito puede hacer que el producto se incline y cause lesiones.

**ADVERTENCIA:** El peso máximo previsto dentro de la cesta de la compra es de 3 kg.

**ADVERTENCIA:** Asegúrese de que todos los dispositivos de bloqueo estén activados antes de su uso.

**ADVERTENCIA:** Para evitar lesiones, asegúrese de mantener alejado a su hijo cuando despliegue y pliegue este cochecito.

**ADVERTENCIA:** No deje que su niño juegue con este cochecito.

**ADVERTENCIA:** Utilice siempre el sistema de retención.

**ADVERTENCIA:** Compruebe que el cuerpo del cochecito o los dispositivos de fijación del asiento estén correctamente enganchados antes de su uso.

**ADVERTENCIA:** No coloque bebidas ni líquidos calientes en el portavasos.

**ADVERTENCIA:** Este producto no es apto para correr o patinar.

**ADVERTENCIA:** No inserte ningún colchón adicional en el cochecito.

**ADVERTENCIA:** No se deben utilizar accesorios que no estén aprobados por el fabricante.

**ADVERTENCIA:** ¡Este cochecito ha sido diseñado para un niño y se utilizará para el transporte de un solo niño!

**ADVERTENCIA:** Utilice siempre la correa de la entrepierna en combinación con el cinturón.

**ADVERTENCIA:** Este cochecito no sustituye a una cuna ni a una cama. Si su hijo necesita dormir, deberá colocarlo en una cuna o cama adecuada.

**ADVERTENCIA:** Sólo se utilizarán piezas de repuesto suministradas o recomendadas por My Babiie.

**ADVERTENCIA:** Cualquier carga sujeta al asa y en la parte posterior del respaldo y en los lados del cochecito afectará la estabilidad del cochecito.

**ADVERTENCIA:** El dispositivo de estacionamiento deberá estar activado al colocar y retirar a los niños.

**ADVERTENCIA:** El capazo no debe utilizarse tan pronto como el niño sea capaz de sentarse solo, darse la vuelta o levantarse sobre sus manos y rodillas. Peso máximo del niño: 9kg

EN1888-1&2:2018 Aprobado

# Información de seguridad y cuidado

---

## Cuidado y mantenimiento

- Compruebe periódicamente que los frenos, ruedas, pestillos, elementos de conexión, correas Los sistemas y las costuras funcionan correctamente.
- No exponga el cochecito a la luz solar intensa.
- Limpiar únicamente con esponja.
- Después de usarlo bajo la lluvia o la nieve, se deben lubricar las ruedas y secar el cochecito para evitar óxido.
- Cuide, limpie y revise este cochecito con regularidad.
- No utilice accesorios que no hayan sido aprobados por el fabricante.

La seguridad de tu hijo es tu responsabilidad.

Si tiene algún problema con este producto o necesita piezas de repuesto, visite [www.mybabiie.com/support](http://www.mybabiie.com/support)

Registre su producto en: [www.mybabiie.com/warranties](http://www.mybabiie.com/warranties)

# Pushchair Do's & Don'ts



## Do use your brakes!

Ensure the parking brake is engaged during the loading and unloading of children & when the pushchair is stationary.

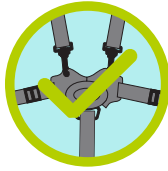

## Do always use the restraint system!

Ensure that the child restraint system is correctly fitted at all times.



## Do keep your pushchair clean and dirt free.

Use a clean white cloth, warm water and a mild detergent to keep your pushchair clean.



## Do always keep two hands on the handles when pushing.

You could lose control of your pushchair if not steering with both hands.



## Do follow manufacturers instructions when assembling and using your pushchair.

For safety, please refer to our instruction manuals or contact customer support if you're unsure.



## Don't use your pushchair up and down stairs!

Don't use your pushchair up or down stairs or to bump kerbs.



## Don't hang bags off the handles!

Bags and other items should not be hung from the handles as this can affect the stability of the pushchair.



## Don't run or skate with your pushchair!

Our products are not suitable for running or skating.



## Don't carry the stroller with baby inside!

Our pushchairs are not designed to be carried with your baby inside them.



## Don't put hot drinks in the cup holder.

Hot drinks burn and can easily spill from the bottle holder.



## Don't jetwash your pushchair.

Some jet washers are very powerful and could damage parts of your pushchair!



## Don't leave your child un-attended in their pushchair.

Always keep your child and pushchair in view to avoid accidents.



## Don't treat your pushchair like a trolley.

Don't load your pushchair up with all your shopping as they are not built for this purpose and could cause damage.



## Don't use your pushchair as a bumper cart!

Damage can easily occur if your pushchair is knocked into other things.



## Don't smoke around your pushchair.

We wouldn't want your pushchair or little one getting hurt or damaged!



## Don't leave your pushchair unattended on extreme gradients.

Even with your brakes on your pushchair is at risk from tipping or sliding on extreme gradients!



## Don't sit in the pushchair unless the user is under the guideline weight.

Our pushchairs are designed to hold a maximum weight. If exceeded this will cause damage!



## Do enjoy your My Babie product!

Go out and have fun adventures with your little one!

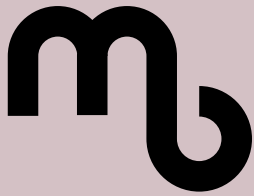

## Register your product

[www.mybabiie.com/warranties](http://www.mybabiie.com/warranties)

In the first instance of needing assistance please contact your original place of purchase.

This product qualifies for 12 month warranty when registered through our website

**mybabiie.com**



My Babiie



@MyBabiieOfficial



My Babiie



@mybabiie\_official



@MyBabiie

My Babiie Ltd, Paddock Wood, Kent, TN12 6EN

My Babiie EU , Generaal Vetterstraat 76A, 1059 BW Amsterdam, The Netherlands